



OUTDOOR & EVENT DISPLAY

CATALOGUE *2026*

MEL ETSEBETH
DIRECTOR







 mel@jigsawmedia.co.za

 +27 (0)82 326 4430

 www.jigsawmedia.co.za



CATALOGUE RANGE:

-  Gifting & Stationery
-  Work, School & Sports Apparel
-  Protective Workwear & Hospitality
-  Headwear
-  Outdoor & Event Display
-  Customise Bags & More

FLOOR VINYL

Let your brand lead the way!

Our Floor Vinyls are manufactured from high quality, anti-slip floor lamination to ensure safety for foot traffic. Vinyls are easy to apply, tough and durable, ensuring longevity of use.

This range is ideal for directional signage in large venues, retail centres, office blocks, schools and hospitals.



SQUARE FLOOR VINYL



DISPLAY-5045

Floor sticker: laminated vinyl, 30 x 30cm, durable, removable, anti-slip, self-adhesive
Branding: digital print

★★
LEGEND
 RANGE

SOLD IN SETS OF 8

ROUND FLOOR VINYL

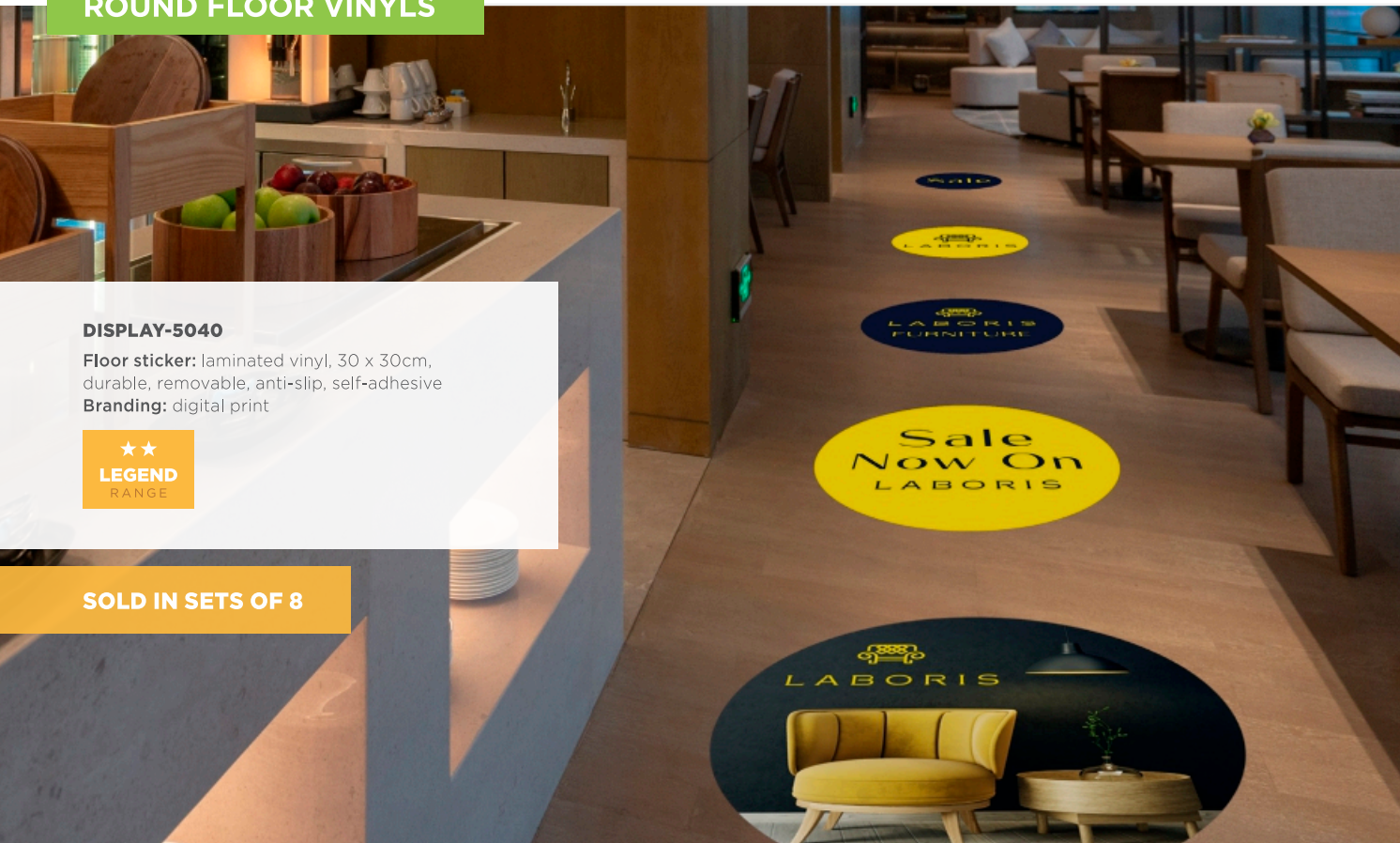

DISPLAY-5040

Floor sticker: laminated vinyl, 30 x 30cm, durable, removable, anti-slip, self-adhesive
Branding: digital print

★★
LEGEND
 RANGE

SOLD IN SETS OF 8

FLOOR STRIP VINYL

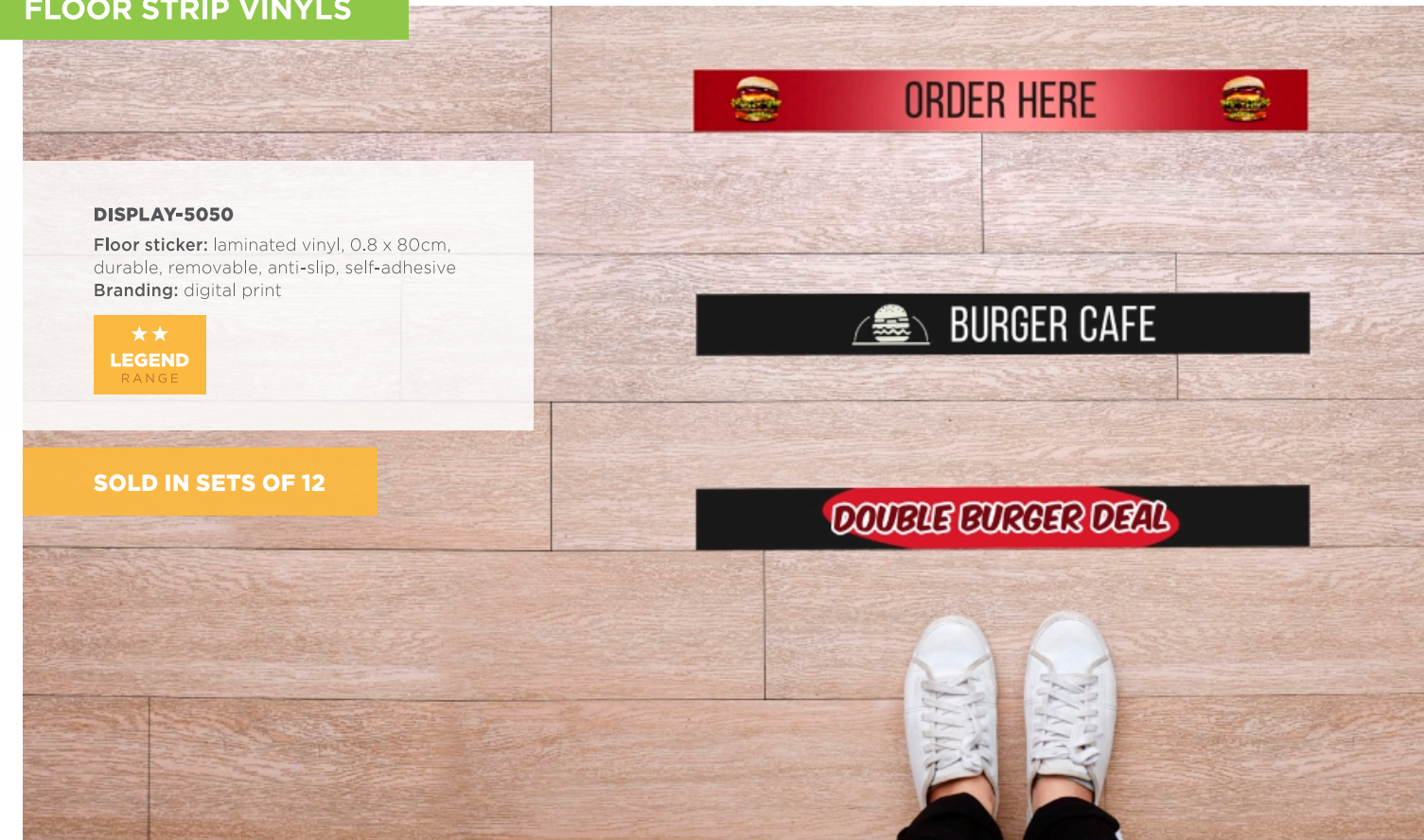

DISPLAY-5050

Floor sticker: laminated vinyl, 0.8 x 80cm, durable, removable, anti-slip, self-adhesive
Branding: digital print

★★
LEGEND
 RANGE

SOLD IN SETS OF 12

ORDER HERE

BURGER CAFE

DOUBLE BURGER DEAL



BANNERS

X-BANNERS

Sporting a unique and funky design, our attention-grabbing X-Banners are the most cost-effective mobile display solution for any brand. Their compact and lightweight design makes them extremely easy-to-assemble and dismantle.

The skins are available in Layflat Display PVC or Polyester Gazebo Display Fabric, which easily attach to the frame and store very well - making this range ideal for interchangeable artwork.

PULL UP BANNERS

Advertising your brand, products or services has never been easier! This range is compact, lightweight and durable, allowing setup within minutes. When all is said and done, the artwork simply retracts into the protective base and fits into a convenient carry bag.

Our Pull Up Banners are available in the following ranges:



CHAMPION RANGE

An entry level option, offering great value without compromising on quality.



LEGEND RANGE

Our middle of the range offering, with a slim design and chromed end caps for an upmarket and refined finish.



OVATION RANGE

Defined by premium quality construction and durability, at an extremely competitive price point.

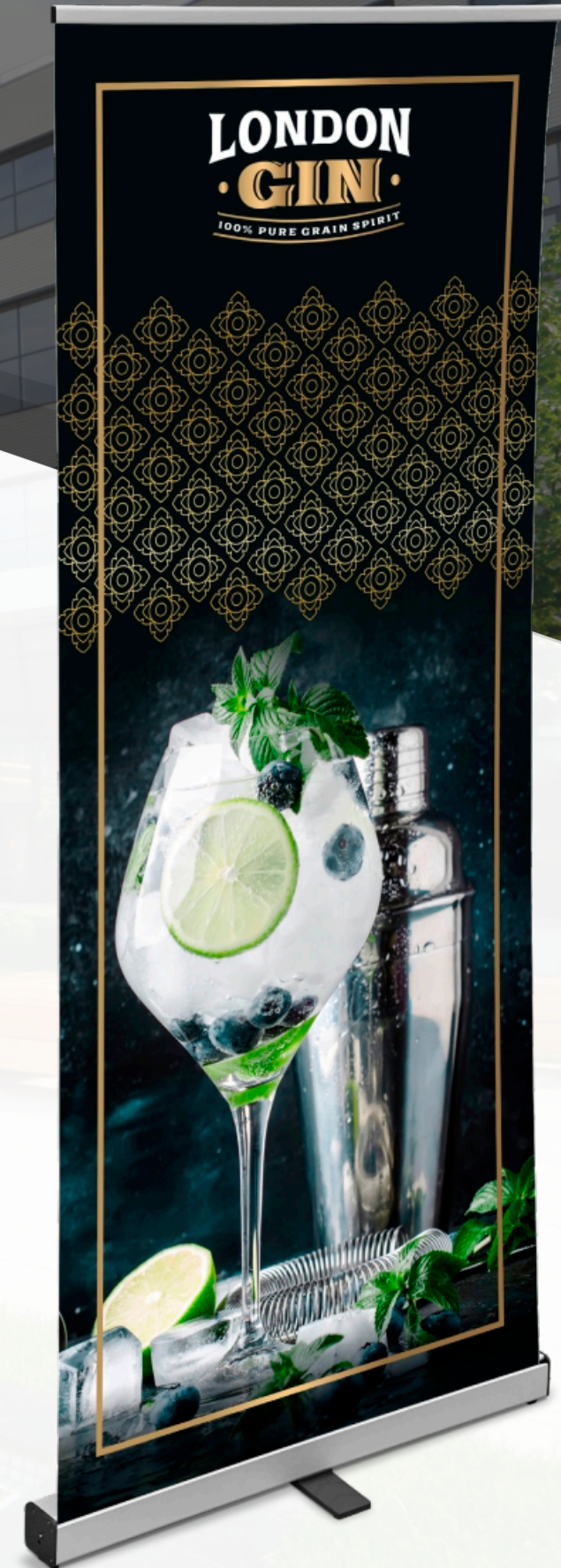

X-BANNERS

SPECIFICATIONS

- **Weight:** 2kg
- **1 x frame:** steel & fibre glass
- **Frame assembled size:** 0.60 x 1.6 x 0.80m
- **Bag:** Nylon
- **Bag size:** 112 x 15cm

	DISPLAY-6000	DISPLAY-6010
Skin included	1 x banner skin	1 x banner skin
Material	Layflat PVC	Gazebo display fabric
Visual size	0.60 x 1.6m	0.60 x 1.6m
Features	Roll-up neatly into carry bag	Roll-up neatly into carry bag. Crease resistant fabric
Branding	Single-sided digital print	Single-sided sublimation
Range		
Refresh the banner for multiple campaigns by buying a new skin		
Reskin Code	SKIN-6000	SKIN-6010



Quick & easy assembly

X-Banner frame folds down for easy storage



PVC banner skin must be rolled to avoid creasing





Carry bag included

X-BANNERS

SPECIFICATIONS

- **Weight:** 2.25kg
- **1 x frame:** steel & fibre glass
- **Frame assembled size:** 0.80 x 1.8 x 0.87m
- **Bag:** Nylon
- **Bag size:** 123 x 17cm

	DISPLAY-6005	DISPLAY-6015
Skin included	1 x banner skin	1 x banner skin
Material	Layflat PVC	Gazebo display fabric
Visual size	0.80 x 1.8m	0.80 x 1.8m
Features	Roll-up neatly into carry bag	Roll-up neatly into carry bag.
Branding	Single-sided digital print	Single-sided sublimation
Range		
Refresh the banner for multiple campaigns by buying a new skin		
Reskin Code	SKIN-6005	SKIN-6015

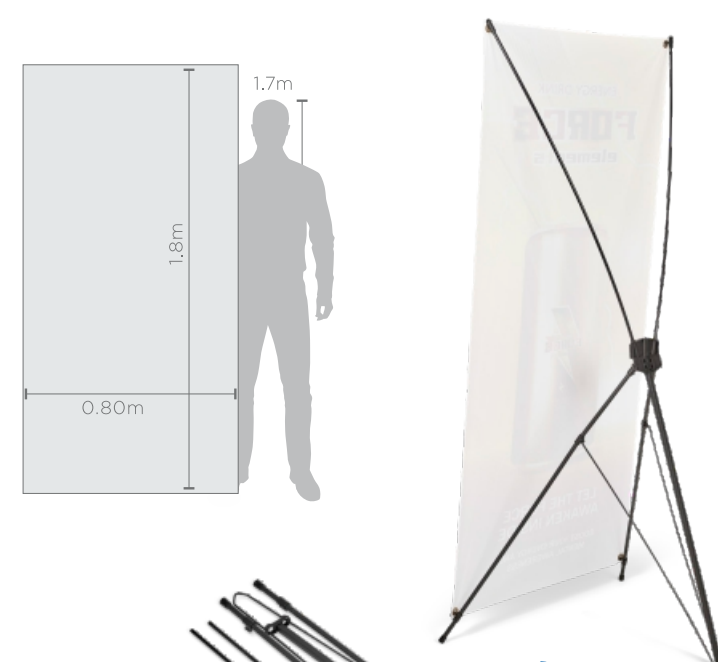

Quick & easy assembly

X-Banner frame folds down for easy storage



Gazebo display fabric





Carry bag included



PULL UP BANNERS

SPECIFICATIONS

- **Weight:** 2.9kg
- **1 x frame:** aluminium
- **Frame assembled size:** 0.85 x 2 x 0.1m
- **Bag:** polyester oxford
- **Bag size:** 90 x 8 x 8cm

	DISPLAY-4000	DISPLAY-4005
Skin included	1 x banner skin	1 x banner skin
Material	Layflat PVC	Gazebo display fabric
Visual size	0.85 x 2m	0.85 x 2m
Branding	Single-sided digital print	Single-sided sublimation
Range		
Refresh the banner for multiple campaigns by buying a new skin		
Reskin Code	SKIN-4000	SKIN-4005

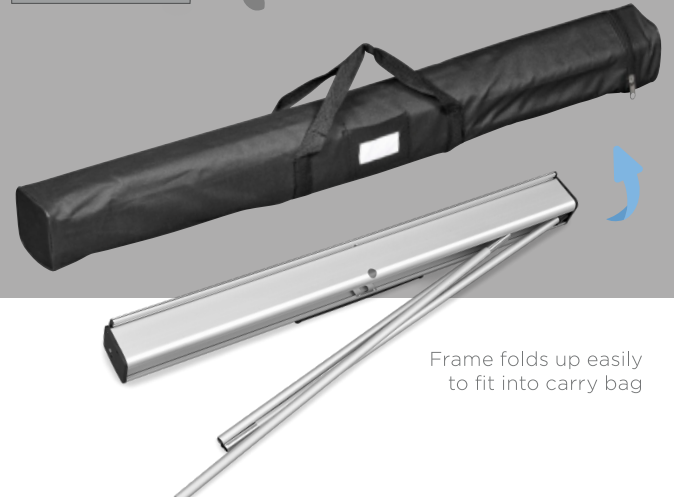
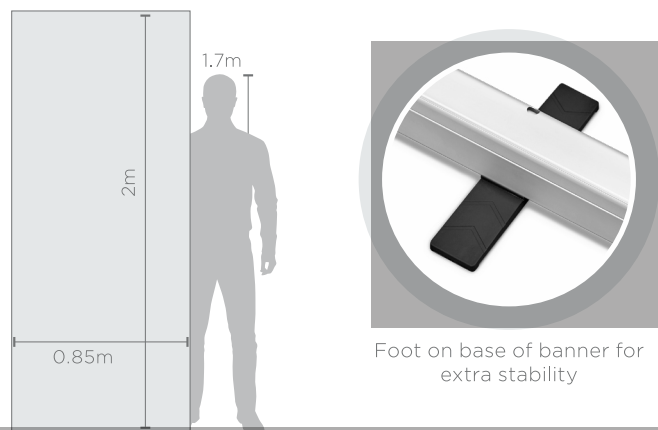

Frame folds up easily to fit into carry bag

To reskin these items, the hardware needs to be returned to supplier to be fitted.



DOUBLE-SIDED PULL UP BANNERS

SPECIFICATIONS

- **Weight:** 5.8kg
- **2 x frames:** aluminium
- **Frame assembled size:** 0.85 x 2 x 0.2m
- 2 interlocking mechanisms, positioned back to back
- **2 x bags:** polyester oxford
- **Bag size:** 90 x 8 x 8cm
- **1 x adapter kit:** PP

	DISPLAY-4030	DISPLAY-4035
Skin included	2 x banner skins	2 x banner skins
Material	Layflat PVC	Gazebo display fabric
Visual size	0.85 x 2m	0.85 x 2m
Branding	2 x single-sided digital prints. One print attached to each mechanism, making branding visible from both sides.	2 x single-sided sublimation prints. One print attached to each mechanism, making branding visible from both sides.
Range		
Refresh the banner for multiple campaigns by buying a new skin		
Reskin Code	2 x SKIN-4000	2 x SKIN-4005

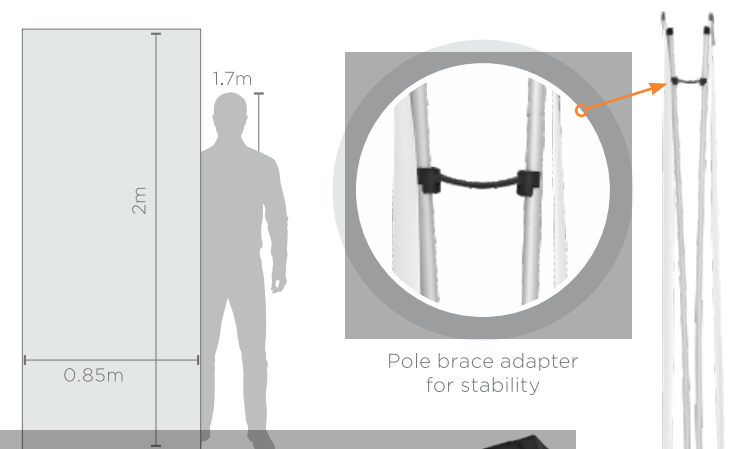

Frame folds up easily to fit into carry bag

1 x interlocking kit included

Convert 2 Champion Pull Up Banners into a double-sided display unit, by adding the ADAPT-4000 interlocking kit.

To reskin these items, the hardware needs to be returned to supplier to be fitted.



PULL UP BANNERS

SPECIFICATIONS

- **Weight:** 4.5kg
- **1 x frame:** aluminium
- **Frame assembled size:** 0.85 x 2 x 0.1m
- **Bag:** polyester oxford
- **Bag size:** 90 x 12 x 13cm

	DISPLAY-4010	DISPLAY-4015
Skin included	1 x banner skin	1 x banner skin
Material	Layflat PVC	Gazebo display fabric
Visual size	0.85 x 2m	0.85 x 2m
Branding	Single-sided digital print	Single-sided sublimation
Range	★★ LEGEND RANGE	★★ LEGEND RANGE
Refresh the banner for multiple campaigns by buying a new skin		
Reskin Code	SKIN-4000	SKIN-4005



To reskin these items, the hardware needs to be returned to supplier to be fitted.



PULL UP BANNERS

SPECIFICATIONS

- **Weight:** 5kg
- **1 x frame:** aluminium
- **Frame assembled size:** 0.85 x 2 x 0.2m
- **Bag:** polyester oxford
- **Bag size:** 92 x 10 x 21cm

	DISPLAY-4020	DISPLAY-4025
Skin included	1 x banner skin	1 x banner skin
Material	Layflat PVC	Gazebo display fabric
Visual size	0.85 x 2m	0.85 x 2m
Branding	Single-sided digital print	Single-sided sublimation
Range	★★★ OVATION RANGE	★★★ OVATION RANGE
Refresh the banner for multiple campaigns by buying a new skin		
Reskin Code	SKIN-4000	SKIN-4005



To reskin these items, the hardware needs to be returned to supplier to be fitted.

BANNER WALLS



Time to book your
dream holiday





STRAIGHT BANNERWALLS

SPECIFICATIONS

- **Weight:** 6.9kg
- **1 x frame:** aluminium
- **Frame assembled size:** 1.52 x 2.25 x 0.3m
- **Bag:** polyester oxford
- **Bag size:** 85 x 29 x 24cm

	DISPLAY-3050
Skin included	1 x bannerwall skin
Material	Polyester display fabric
Visual size	1.52 x 2.25m
Features	Durable fabric
Branding	Single-sided sublimation
Range	★★ LEGEND RANGE
Refresh the banner for multiple campaigns by buying a new skin	
Reskin Code	SKIN-3050

Landscape or portrait orientation

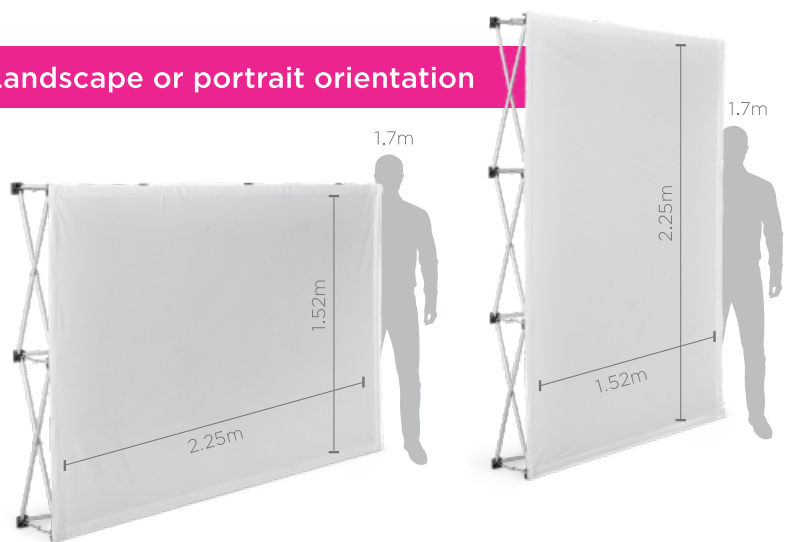

Collapsible scissor frame is made from sturdy aluminium extrusions and fitted with recycled, plastic interlocking connectors



Carry bag included



Collapsible bannerwall fits easily into carry bag



STRAIGHT BANNERWALLS



	1 DISPLAY-3055	2 DISPLAY-3060	3 DISPLAY-3065	4 DISPLAY-3070
Weight	9kg	11.2kg	13.9kg	15.6kg
Hardware	1 x frame: aluminium	1 x frame: aluminium	1 x frame: aluminium	1 x frame: aluminium
Frame assembled size	2.25 x 2.25 x 0.3m	3 x 2.25 x 0.3m	3.7 x 2.25 x 0.3m	4.45 x 2.25 x 0.3m
Bag material	Polyester oxford	Polyester oxford	Polyester oxford	Polyester oxford
Bag size	85 x 29 x 24cm	85 x 29 x 27cm	85 x 29 x 50cm	85 x 29 x 50cm
Skin included	1 x bannerwall skin	1 x bannerwall skin	1 x bannerwall skin	1 x bannerwall skin
Material	Polyester display fabric	Polyester display fabric	Polyester display fabric	Polyester display fabric
Visual size	2.25 x 2.25m	3 x 2.25m	3.7 x 2.25m	4.45 x 2.25m
Features	Durable fabric	Durable fabric	Durable fabric	Durable fabric
Branding	Single-sided sublimation	Single-sided sublimation	Single-sided sublimation	Single-sided sublimation
Range	★★ LEGEND RANGE	★★ LEGEND RANGE	★★ LEGEND RANGE	★★ LEGEND RANGE
Refresh the banner for multiple campaigns by buying a new skin				
Reskin Code	SKIN-3055	SKIN-3060	SKIN-3065	SKIN-3070

Collapsible scissor frame

Recycled, plastic interlocking connectors

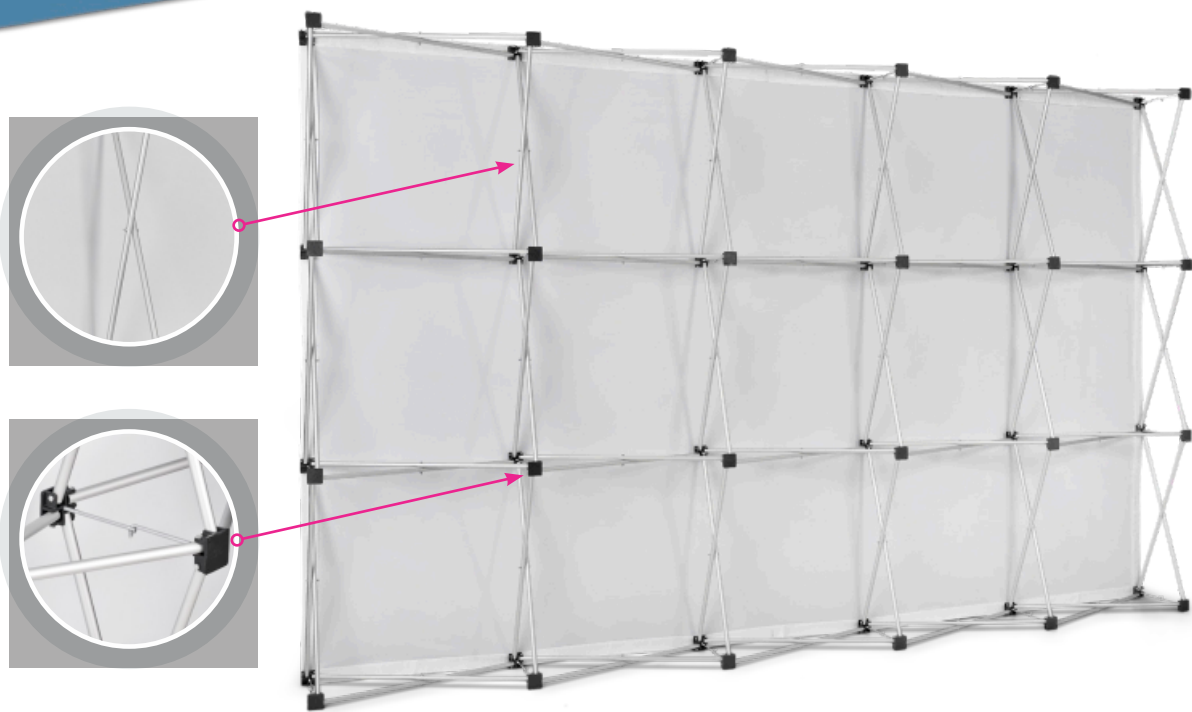

Carry bag included

Collapsible bannerwall fits easily into carry bag



INDOOR DISPLAY



INDOOR DISPLAY



DOUBLE-SIDED STRAIGHT BANNERWALLS

SPECIFICATIONS

- Weight: 6.9kg
- 1 x frame: aluminium
- Frame assembled size: 1.52 x 2.25 x 0.3m
- Double-sided
- Bag: polyester oxford
- Bag size: 85 x 29 x 24cm

Carry bag included



Second bannerwall skin



Collapsible bannerwall fits easily into carry bag

Landscape or portrait orientation

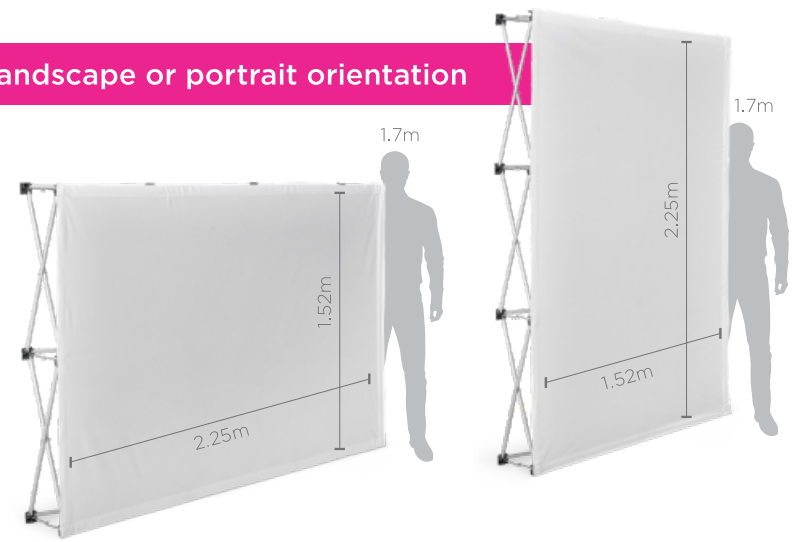

DISPLAY-3075	
Skin included	2 x bannerwall skins
Material	Polyester display fabric
Visual size	1.52 x 2.25m
Features	Durable fabric
Branding	2 x single-sided sublimation prints. One print attached to each side of the frame, making branding visible from both sides.
Range	★★ LEGEND RANGE
Refresh the banner for multiple campaigns by buying a new skin	
Reskin Code	2 x SKIN-3050



Skin easily attaches to frame with Velcro



Velcro is fitted around all edges of the frame allowing prints to be attached to both sides

DOUBLE-SIDED STRAIGHT BANNERWALLS



	1 DISPLAY-3080	2 DISPLAY-3085	3 DISPLAY-3090	4 DISPLAY-3095
Weight	9kg	11.2kg	13.9kg	15.6kg
Hardware	1 x frame: aluminium	1 x frame: aluminium	1 x frame: aluminium	1 x frame: aluminium
Frame assembled size	2.25 x 2.25 x 0.3m	3 x 2.25 x 0.3m	3.7 x 2.25 x 0.3m	4.45 x 2.25 x 0.3m
Bag material	Polyester oxford	Polyester oxford	Polyester oxford	Polyester oxford
Bag size	85 x 29 x 24cm	85 x 29 x 27cm	85 x 29 x 50cm	85 x 29 x 50cm
Skin included	2 x bannerwall skins	2 x bannerwall skins	2 x bannerwall skins	2 x bannerwall skins
Material	Polyester display fabric	Polyester display fabric	Polyester display fabric	Polyester display fabric
Visual size	2.25 x 2.25m	3 x 2.25m	3.7 x 2.25m	4.45 x 2.25m
Features	Durable fabric	Durable fabric	Durable fabric	Durable fabric
Branding	2 x single-sided sublimation prints. One print attached to each side of the frame, making branding visible from both sides.	2 x single-sided sublimation prints. One print attached to each side of the frame, making branding visible from both sides.	2 x single-sided sublimation prints. One print attached to each side of the frame, making branding visible from both sides.	2 x single-sided sublimation prints. One print attached to each side of the frame, making branding visible from both sides.
Range	★★ LEGEND RANGE	★★ LEGEND RANGE	★★ LEGEND RANGE	★★ LEGEND RANGE
Refresh the banner for multiple campaigns by buying a new skin				
Reskin Code	2 x SKIN-3055	2 x SKIN-3060	2 x SKIN-3065	2 x SKIN-3070





CURVED BANNERWALLS



	1 DISPLAY-3000	2 DISPLAY-3005	3 DISPLAY-3010	4 DISPLAY-3015	5 DISPLAY-3020
Weight	8kg	9.2kg	11.3kg	14.2kg	16.4kg
Hardware	1 x frame: aluminium	1 x frame: aluminium	1 x frame: aluminium	1 x frame: aluminium	1 x frame: aluminium
Frame assembled size	1.45 x 2.25 x 0.3m	2.15 x 2.25 x 0.3m	2.85 x 2.25 x 0.3m	3.5 x 2.25 x 0.3m	4.2 x 2.25 x 0.3m
Bag material	Polyester oxford	Polyester oxford	Polyester oxford	Polyester oxford	Polyester oxford
Bag size	85 x 24 x 27cm	85 x 30 x 27cm	85 x 27 x 33cm	85 x 30 x 38cm	82 x 25 x 50cm
Skin included	1 x bannerwall skin	1 x bannerwall skin	1 x bannerwall skin	1 x bannerwall skin	1 x bannerwall skin
Material	Polyester display fabric	Polyester display fabric	Polyester display fabric	Polyester display fabric	Polyester display fabric
Visual size	1.45 x 2.25m	2.15 x 2.25m	2.85 x 2.25m	3.5 x 2.25m	4.2 x 2.25m
Features	Durable fabric	Durable fabric	Durable fabric	Durable fabric	Durable fabric
Branding	Single-sided sublimation	Single-sided sublimation	Single-sided sublimation	Single-sided sublimation	Single-sided sublimation
Range	★★ LEGEND RANGE	★★ LEGEND RANGE	★★ LEGEND RANGE	★★ LEGEND RANGE	★★ LEGEND RANGE
Refresh the banner for multiple campaigns by buying a new skin					
Reskin Code	SKIN-3000	SKIN-3005	SKIN-3010	SKIN-3015	SKIN-3020

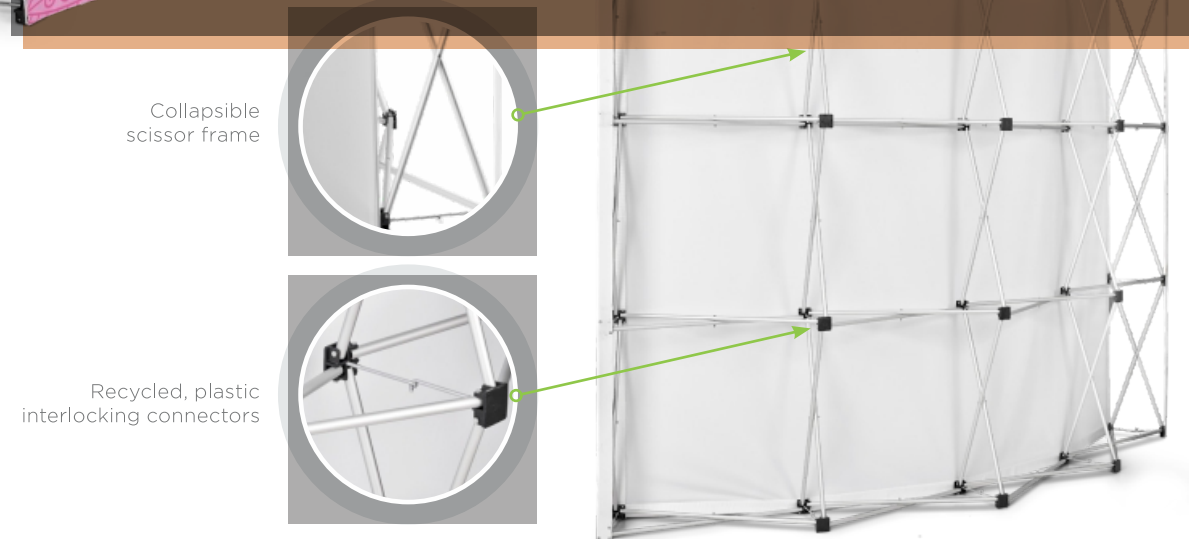



CURVED BANNERWALLS WITH WINGS



	1 DISPLAY-3025	2 DISPLAY-3030	3 DISPLAY-3035	4 DISPLAY-3040	5 DISPLAY-3045
Weight	8kg	9.2kg	11.3kg	14.2kg	16.4kg
Hardware	1 x frame: aluminium	1 x frame: aluminium	1 x frame: aluminium	1 x frame: aluminium	1 x frame: aluminium
Frame assembled size	1.45 x 2.25 x 0.3m	2.15 x 2.25 x 0.3m	2.85 x 2.25 x 0.3m	3.5 x 2.25 x 0.3m	4.2 x 2.25 x 0.3m
Bag material	Polyester oxford	Polyester oxford	Polyester oxford	Polyester oxford	Polyester oxford
Bag size	85 x 24 x 27cm	85 x 30 x 27cm	85 x 27 x 33cm	85 x 30 x 38cm	82 x 25 x 50cm
Wings material	2 x wings: PP	2 x wings: PP	2 x wings: PP	2 x wings: PP	2 x wings: PP
Wing features	Allows for wrap around visuals	Allows for wrap around visuals	Allows for wrap around visuals	Allows for wrap around visuals	Allows for wrap around visuals
Skin included	1 x bannerwall skin	1 x bannerwall skin	1 x bannerwall skin	1 x bannerwall skin	1 x bannerwall skin
Material	Polyester display fabric	Polyester display fabric	Polyester display fabric	Polyester display fabric	Polyester display fabric
Visual size	2.37 x 2.25m	3.04 x 2.25m	3.7 x 2.25m	4.38 x 2.25m	5.08 x 2.25m
Features	Durable fabric	Durable fabric	Durable fabric	Durable fabric	Durable fabric
Branding	Single-sided sublimation	Single-sided sublimation	Single-sided sublimation	Single-sided sublimation	Single-sided sublimation
Range	★★ LEGEND RANGE	★★ LEGEND RANGE	★★ LEGEND RANGE	★★ LEGEND RANGE	★★ LEGEND RANGE
Refresh the banner for multiple campaigns by buying a new skin					
Reskin Code	SKIN-3025	SKIN-3030	SKIN-3035	SKIN-3040	SKIN-3045

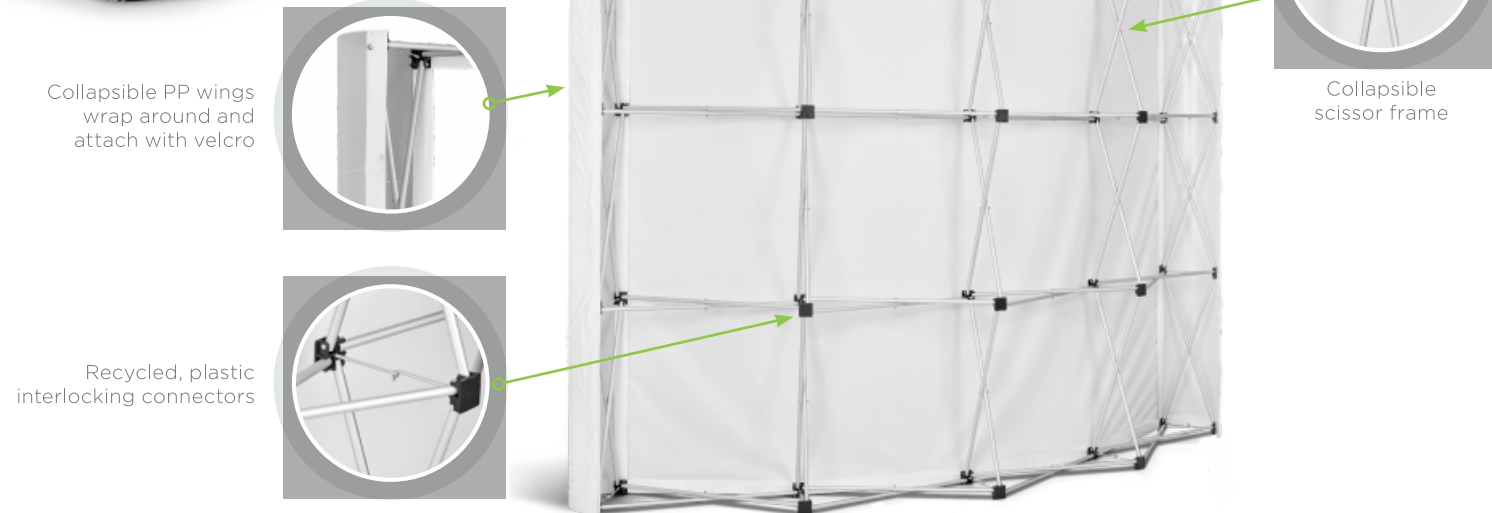

TABLE CLOTHS

Make the most of your space, maximise your brand exposure and enhance your overall appearance with our range of slip over, spandex, fabric and PVC Table Cloths.

PVC TABLE CLOTHS



DISPLAY-5020

Weight: 0.32kg

Material: PVC

Size: 2 x 1.25m

Features: durable, lightweight, wipe-down, knife-cut edge

Branding: single-sided digital print



SLIP OVER TABLE CLOTHS



DISPLAY-5035

Weight: 1.8kg

Material: polyester spandex

Size: tailored to fit a standard trestle table: 1.83 x 0.76 x 0.75m

Features: fitted table cloth, durable, lightweight, washable, hemmed

Branding: single-sided sublimation

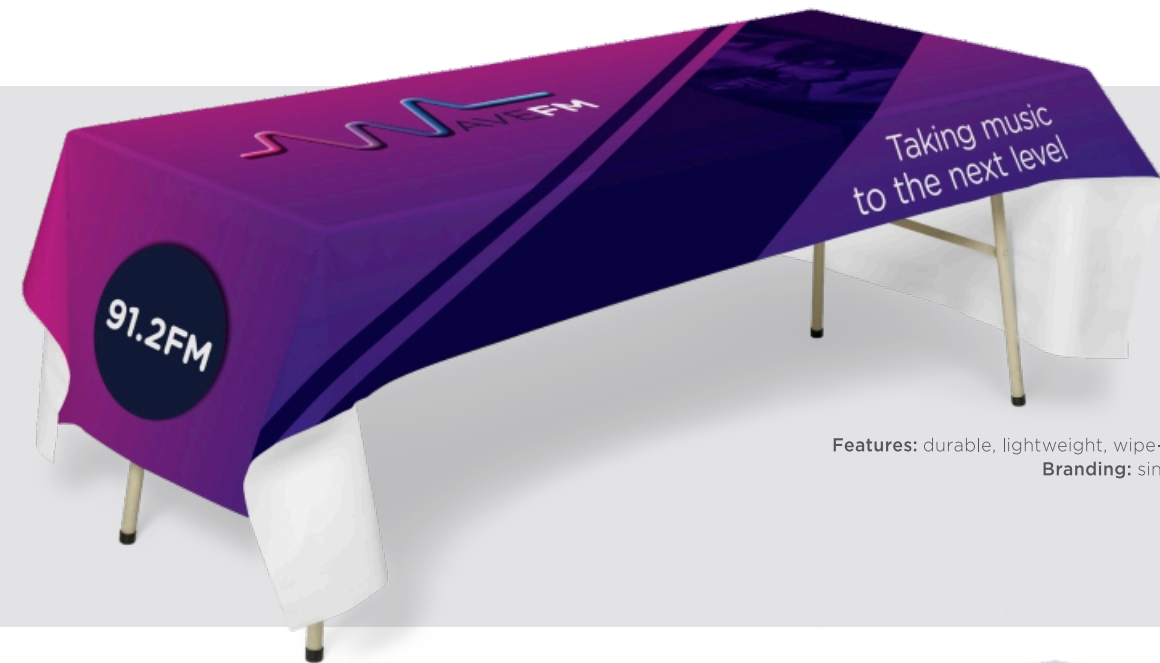

DISPLAY-5025

Weight: 0.47kg

Material: PVC

Size: 3 x 1.25m

Features: durable, lightweight, wipe-down, knife-cut edge

Branding: single-sided digital print



DISPLAY-5055

Weight: 1.8kg

Material: polyester display fabric

Size: tailored to fit a standard trestle table: 1.83 x 0.76 x 0.75m

Features: fitted table cloth, durable, washable, hemmed

Branding: single-sided sublimation



DISPLAY-5030

Weight: 0.55kg

Material: PVC

Size: 3.5 x 1.25m

Features: durable, lightweight, wipe-down, knife-cut edge

Branding: single-sided digital print



FABRIC TABLE CLOTHS



DISPLAY-5000

Weight: 0.51kg
Material: polyester display fabric
Size: 2 x 1m
Features: durable, lightweight, washable, hemmed
Branding: single-sided sublimation



DISPLAY-5010

Weight: 1.255kg
Material: polyester display fabric
Size: 3.5 x 1.5m
Features: durable, lightweight, washable, hemmed
Branding: single-sided sublimation



DISPLAY-5005

Weight: 0.90kg
Material: polyester display fabric
Size: 2.5 x 1.5m
Features: durable, lightweight, washable, hemmed
Branding: single-sided sublimation



DISPLAY-5015

Weight: 1.84kg
Material: polyester display fabric
Size: 3.35 x 2.25m
Features: durable, lightweight, washable, hemmed
Branding: single-sided sublimation





FLAGS

DESK FLAGS

Ideal for client gifts, Desk Flags offer a unique platform to show your support, back a team, unite for a cause or celebrate your heritage.

HAND FLAGS

Let your brand make waves!

Ideal for sporting events, marches and commemorating special events or holidays – this range is bound to be a crowd-pleasing favourite.



FLAG FOUNTAINS

Available in four and five pole configurations, these flags attach to a single base allowing you to promote multiple messages simultaneously.

The lightweight, anti-fray fabric allows for a reversed visual – ideal for car dealerships, forecourts, brand activations and events.



DESK FLAGS

DISPLAY-1000

Weight: 0.15kg
Pole: PP, 30.8cm
Base: PP, 1.7 x 9.7cm dia
Material: polyester warp knit, anti-fray
Visual size: 15 x 10cm
Branding: single-sided sublimation

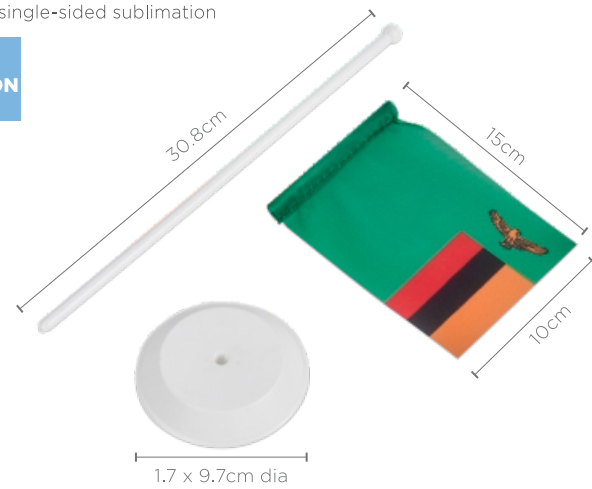

DISPLAY-1005

Weight: 0.16kg
Pole: PP, 30.8cm
Base: PP, 1.7 x 9.7cm dia
Material: polyester warp knit, anti-fray
Visual size: 22 x 15cm
Branding: single-sided sublimation



HAND FLAGS

1 DISPLAY-1010

Weight: 0.20kg
Dowel: wood, 45 x 0.6cm dia
Material: polyester warp knit, anti-fray
Visual size: 20 x 30cm
Branding: single-sided sublimation



2 DISPLAY-1015

Weight: 0.22kg
Dowel: wood, 90 x 1cm dia
Material: polyester warp knit, anti-fray
Visual size: 30 x 45cm
Branding: single-sided sublimation

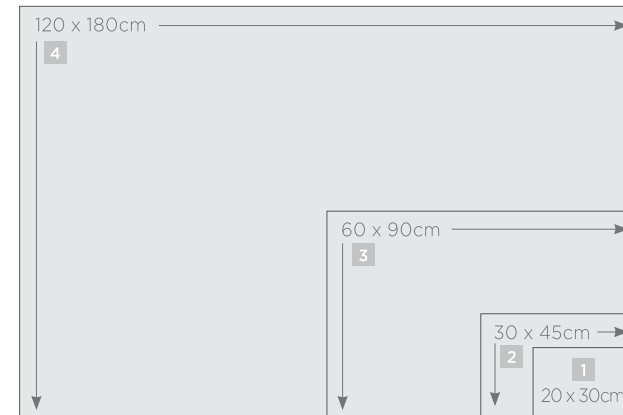

3 DISPLAY-1020

Weight: 0.55kg
Dowel: wood, 140 x 1.6cm dia
Material: polyester warp knit, anti-fray
Visual size: 60 x 90cm
Branding: single-sided sublimation



4 DISPLAY-1040

Weight: 0.6kg
Dowel: wood, 180 x 1.6cm dia
Material: polyester warp knit, anti-fray
Visual size: 120 x 180cm
Branding: single-sided sublimation



FLAG FOUNTAINS



1 Flag fountain base

2 Flag fountain base



1
DISPLAY-1025
 Weight: 14.35kg
 Hardware: 4 x poles: aluminium & steel, 6m
 Hardware bag: polyester oxford, 144 x 34cm
 Base: steel, 1 x 1m
 Base bag: Polyester oxford, 60 x 20 x 15cm
 Material: 4 x flag skins, polyester warp knit, anti-fray
 Visual size: 1 x 4m
 Branding: single-sided sublimation

Refresh the flag fountain for multiple campaigns by buying a new skin
 Reskin code: FLAG-1030

2
DISPLAY-1030
 Weight: 16.05kg
 Hardware: 5 x poles: aluminium & steel, 6m
 Hardware bag: polyester oxford, 144 x 34cm
 Base: steel, 1 x 1m
 Base bag: Polyester oxford, 60 x 20 x 15cm
 Material: 5 x flag skins, polyester warp knit, anti-fray
 Visual size: 1 x 4m
 Branding: single-sided sublimation

Refresh the flag fountain for multiple campaigns by buying a new skin
 Reskin code: FLAG-1030

3

3
DISPLAY-1035
 Weight: 8.1kg
 Hardware: 4 x poles: aluminium & steel, 5m
 Hardware bag: polyester oxford, 137 x 34cm
 Base: steel, 0.79 x 0.79m
 Base bag: Polyester oxford, 60 x 16 x 15cm
 Material: 4 x flag skins, polyester warp knit, anti-fray
 Visual size: 1 x 3m
 Branding: single-sided sublimation

Refresh the flag fountain for multiple campaigns by buying a new skin
 Reskin code: FLAG-1025

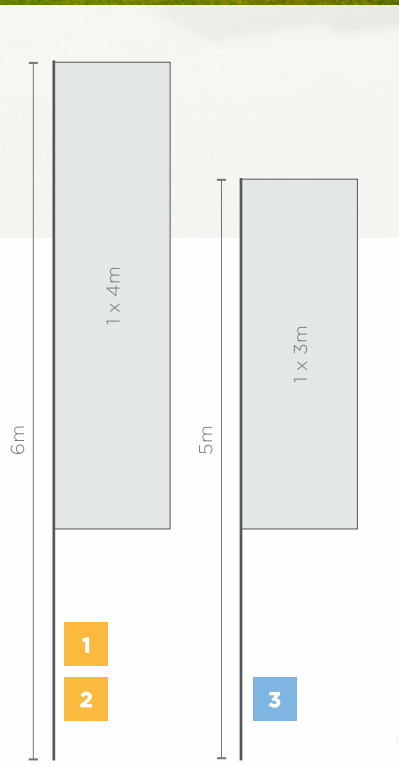



POP-UP BANNER

This high-impact display solution literally pops up and assembles itself!

Our Pop-Up Banners are manufactured with a crease-resistant Polyester, which easily twists and folds into a convenient carry bag.

Ideal for golf days and sporting events - the double-sided design allows you to maximise your brand exposure.



POP-UP BANNER



Twist and fold to fit into bag

Double-sided for maximum visibility



1.7m

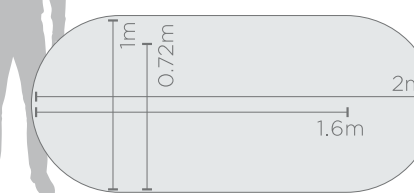

	DISPLAY-8020	VI-AM-210-D
Weight	3.1kg	2.9kg
Hardware	1 x frame: fibre rod	1 x frame: fibre rod
Frame assembled size	2 x 1 x 0.4m	1.6 x 0.72m
Bag material	Polyester oxford	Polyester oxford
Bag size	85cm dia	85cm dia
Skin included	2 x pop-up skins	2 x pop-up skins
Material	Polyester display fabric	Polyester display fabric
Visual size	1.98 x 0.9m	1.6 x 0.72m
Features	Crease resistant, lightweight, easy setup	Crease resistant, lightweight, easy setup
Accessories	4 x ground spikes: steel	4 x ground spikes: steel
Branding	2 x single-sided sublimation prints tailored to fit the frame, making branding visible from both sides.	2 x single-sided sublimation prints tailored to fit the frame, making branding visible from both sides.
Range	★★ LEGEND RANGE	★★ LEGEND RANGE
Refresh the banner for multiple campaigns by buying a new skin		
Reskin Code	2 x SKIN-8020	2 x PU-AM-4-D

To reskin these items, the hardware needs to be returned to supplier to be fitted.



SUBLIMATED A-FRAME BANNERS

Ideal for indoor or outdoor use, our A-Frames are manufactured with a sturdy aluminium frame, which is lightweight and easy-to-assemble. The skins easily attach to the frame with Velcro straps making this solution ideal for interchangeable artwork.

This display can be purchased with your choice of Blockout PVC Skins or Polyester Display Fabric Skins depending on your requirements.

BLOCKOUT PVC

A lightweight and resilient substrate with 100% opacity, which prevents light from filtering through the display - ensuring maximum visibility indoors and outdoors.

POLYESTER DISPLAY FABRIC

A lightweight, crease-resistant fabric that can be washed in cold water and easily stored - recommended for indoor use.



Fabric skins have white backing

Double-sided for maximum visibility

Blockout PVC skins have black backing

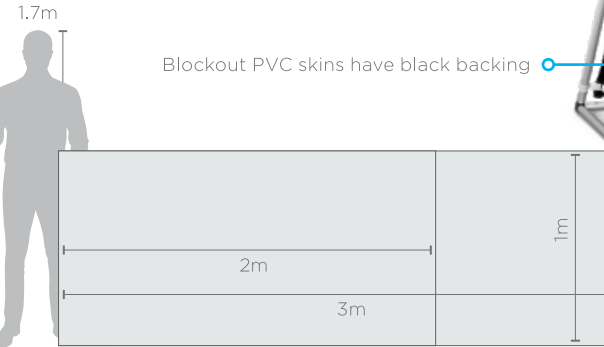

Carry bag included

A-FRAME BANNERS

	DISPLAY-8000	DISPLAY-8005	DISPLAY-8010	DISPLAY-8015
Weight	3.2kg	3.8kg	3.2kg	3.8kg
Hardware	1 x frame: aluminium	1 x frame: aluminium	1 x frame: aluminium	1 x frame: aluminium
Frame assembled size	2 x 1 x 1m	3 x 1 x 1m	2 x 1 x 1m	3 x 1 x 1m
Bag material	Polyester oxford	Polyester oxford	Polyester oxford	Polyester oxford
Bag size	129 x 23cm	129 x 23cm	129 x 23cm	129 x 23cm
Skin included	2 x A-frame skins	2 x A-frame skins	2 x A-frame skins	2 x A-frame skins
Material	PVC	PVC	Polyester display fabric	Polyester display fabric
Visual size	1.95 x 0.95m	2.95 x 0.95m	1.95 x 0.95m	2.95 x 0.95m
Features	UV stable	UV stable	Crease resistant	Crease resistant
Branding	2 x single-sided digital prints tailored to fit the frame, making branding visible from both sides.	2 x single-sided digital prints tailored to fit the frame, making branding visible from both sides.	2 x single-sided sublimation prints tailored to fit the frame, making branding visible from both sides.	2 x single-sided sublimation prints tailored to fit the frame, making branding visible from both sides.
Range	★ CHAMPION RANGE	★ CHAMPION RANGE	★★ LEGEND RANGE	★★ LEGEND RANGE
Refresh the banner for multiple campaigns by buying a new skin				
Reskin Code	2 x SKIN-8000	2 x SKIN-8005	2 x SKIN-8010	2 x SKIN-8015



FADE RESISTANT A-FRAME BANNERS

Our Fade Resistant Displays are printed with state-of-the-art Latex Gen-4 inks, boasting the widest colour gamut on the market.



This allows us to print the widest range of colours within the colour spectrum and produce the most vibrant and vivid print results.

The inks have a low environmental impact, are UV stable and scratch resistant, providing great durability for long-term outdoor exposure.

Premium polyester fabric with a unique print-guard coating is used for all of our Fade Resistant A-Frame Banners



A-FRAME BANNERS

	VI-AM-148-D	VI-AM-146-D
Weight	3.2kg	3.8kg
Hardware	1 x frame: aluminium	1 x frame: aluminium
Frame assembled size	2 x 1 x 1m	3 x 1 x 1m
Bag material	Polyester oxford	Polyester oxford
Bag size	129 x 23cm	129 x 23cm
Skin included	2 x A-frame skins	2 x A-frame skins
Material	Polyester print-guard fabric, water resistant	Polyester print-guard fabric, water resistant
Visual size	1.95 x 0.95m	2.95 x 0.95m
Features	Fade resistant	Fade resistant
Branding	Latex Gen-4 printing	Latex Gen-4 printing
Range		
Refresh the banner for multiple campaigns by buying a new skin		
Reskin Code	AF-AM-7-D	AF-AM-8-D



Carry bag included

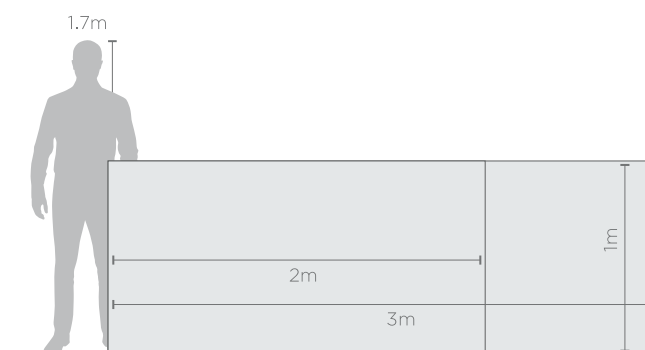

FLYING BANNERS

Available in a variety of shapes and sizes, this diverse range has been designed to withstand the elements while offering high-impact visibility for your brand.

Our entire range of Arcfin, Sharkfin and Telescopic Flying Banners include a ground spike and convenient carry bag. These displays are predominantly used outdoors, however can be converted into indoor displays with our range of optional extras.

SINGLE-SIDED FLYING BANNERS

Only sold in pairs - this option offers exceptional value at an extremely competitive price point.

DOUBLE-SIDED FLYING BANNERS

Two skins are tailored back-to-back with blockout material in between to offer a perfect double-sided visual.





ARCFIN FLYING BANNERS

	1 DISPLAY-7022	2 DISPLAY-7023	3 DISPLAY-7024
	Sold in sets of 2, info below is per unit		
Weight	1.5kg	1.7kg	3.6kg
Hardware	2 x poles: aluminium	2 x poles: aluminium	3 x poles: aluminium
Frame assembled size	2m	3m	4m
Accessories	2 x rods: fibre 1 x ground spike: steel	2 x rods: fibre 1 x ground spike: steel	2 x rods: fibre 1 x ground spike: steel
Bag material	Polyester oxford	Polyester oxford	Polyester oxford
Bag size	137 x 18cm	137 x 18cm	137 x 18cm
Skin included	1 x banner skin	1 x banner skin	1 x banner skin
Material	Polyester warp knit	Polyester warp knit	Polyester warp knit
Visual size	0.61 x 2.59m	0.68 x 3.83m	0.68 x 4.87m
Features	Anti-fray	Anti-fray	Anti-fray
Branding	Single-sided sublimation	Single-sided sublimation	Single-sided sublimation
Range	★★ LEGEND RANGE	★★ LEGEND RANGE	★★ LEGEND RANGE
Refresh the banner for multiple campaigns by buying a new skin (SOLD IN SETS OF 2)			
Reskin Code	SKIN-7022	SKIN-7023	SKIN-7024

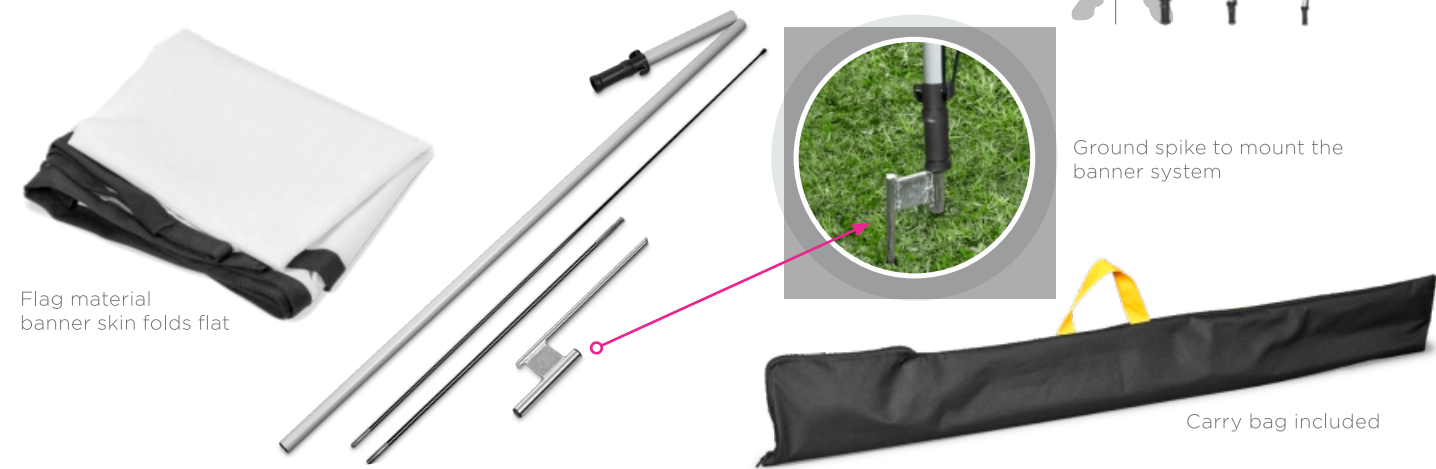
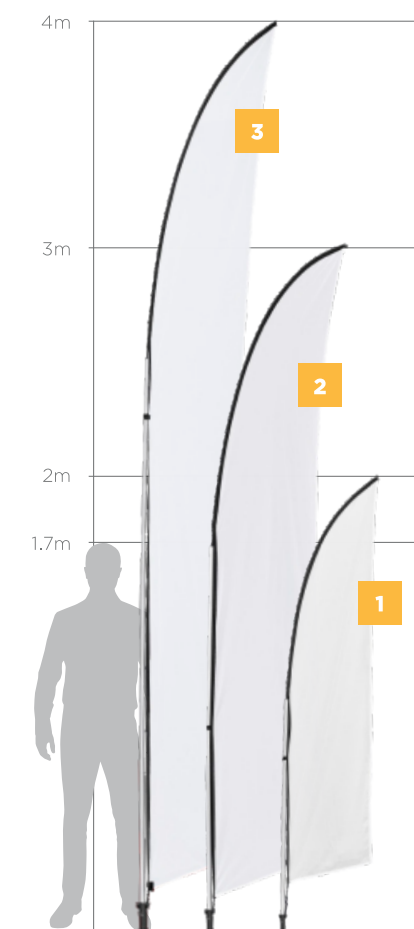

OPTIONAL EXTRAS FOR THE ARCFIN FLYING BANNERS



DISPLAY-7000
LEGEND FLYING BANNER GROUND SPIKE
ground spike: steel

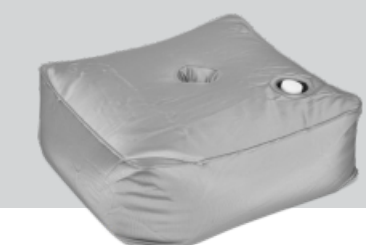

DISPLAY-7050
LEGEND FLYING BANNER 20L SQUARE WATER BASE
base: PP, refill with 20L water, collapsible

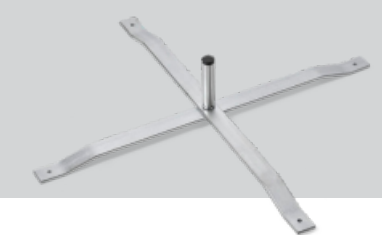

DISPLAY-7051
LEGEND FLYING BANNER SCISSOR BASE
base: steel, size: 60 x 60cm

DOUBLE-SIDED ARCFIN FLYING BANNERS

	1 DISPLAY-7032	2 DISPLAY-7033	3 DISPLAY-7034
Weight	2kg	2.2kg	3.2kg
Hardware	2 x poles: aluminium	2 x poles: aluminium	3 x poles: aluminium
Frame assembled size	2m	3m	4m
Accessories	2 x rods: fibre	2 x rods: fibre	2 x rods: fibre
	1 x ground spike: steel	1 x ground spike: steel	1 x ground spike: steel
Bag material	Polyester oxford	Polyester oxford	Polyester oxford
Bag size	137 x 18cm	137 x 18cm	137 x 18cm
Skin included	1 x banner skin	1 x banner skin	1 x banner skin
Material	Polyester warp knit	Polyester warp knit	Polyester warp knit
Visual size	0.61 x 2.59m	0.68 x 3.83m	0.68 x 4.87m
Features	Anti-fray	Anti-fray	Anti-fray
Branding	Double-sided sublimation	Double-sided sublimation	Double-sided sublimation
Range	★★ LEGEND RANGE	★★ LEGEND RANGE	★★ LEGEND RANGE
Refresh the banner for multiple campaigns by buying a new skin			
Reskin Code	SKIN-7032	SKIN-7033	SKIN-7034

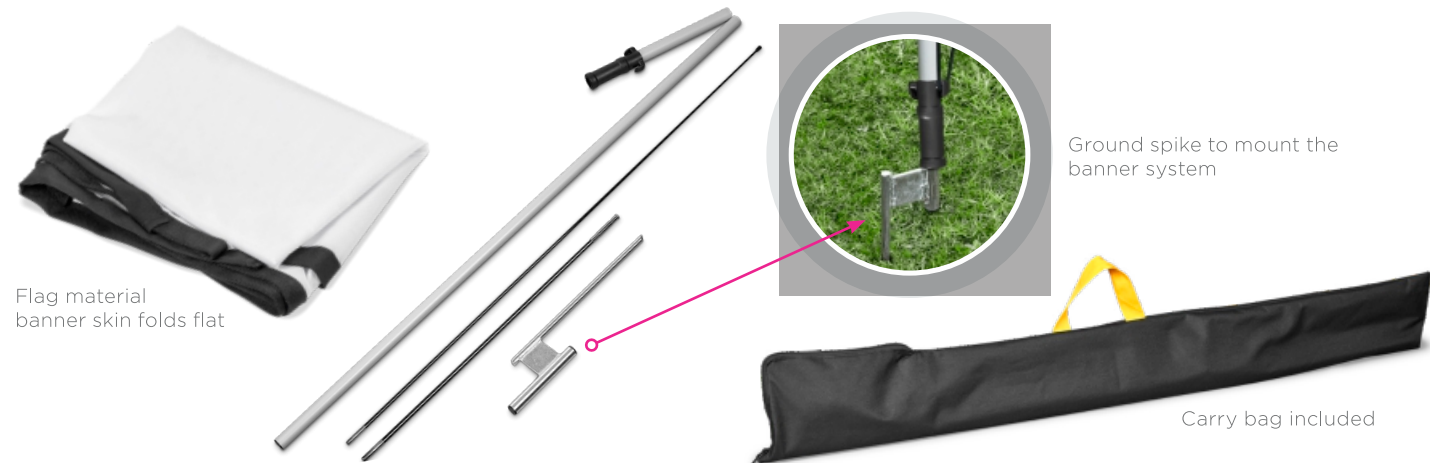
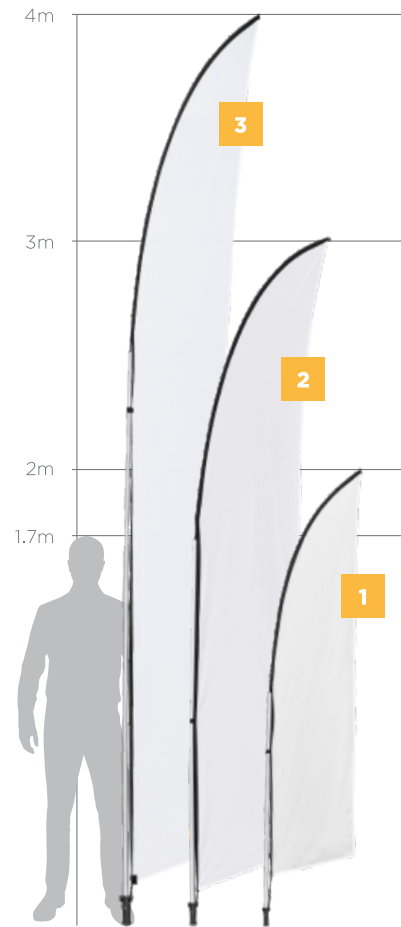

OPTIONAL EXTRAS FOR THE DOUBLE-SIDED ARCFIN FLYING BANNERS



DISPLAY-7000

LEGEND FLYING BANNER GROUND SPIKE
ground spike: steel

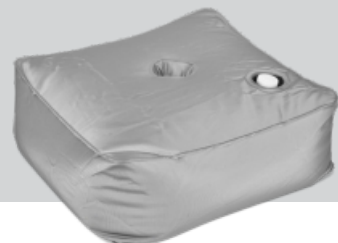

DISPLAY-7050

LEGEND FLYING BANNER 20L SQUARE WATER BASE
base: PP, refill with 20L water, collapsible

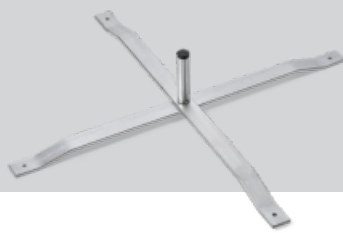

DISPLAY-7051

LEGEND FLYING BANNER SCISSOR BASE
base: steel, size: 60 x 60cm





SHARKFIN FLYING BANNERS

	1 DISPLAY-7002	2 DISPLAY-7003	3 DISPLAY-7004
	Sold in sets of 2, info below is per unit		
Weight	1.4kg	1.7kg	1.9kg
Hardware	2 x poles: aluminium	2 x poles: aluminium	3 x poles: aluminium
Frame assembled size	2m	3m	4m
Accessories	2 x rods: fibre	2 x rods: fibre	2 x rods: fibre
	1 x ground spike: steel	1 x ground spike: steel	1 x ground spike: steel
Bag material	Polyester oxford	Polyester oxford	Polyester oxford
Bag size	137 x 18cm	137 x 18cm	137 x 18cm
Skin included	1 x banner skin	1 x banner skin	1 x banner skin
Material	Polyester warp knit	Polyester warp knit	Polyester warp knit
Visual size	0.98 x 2.24m	1.38 x 3.3m	1.14 x 4.4m
Features	Anti-fray	Anti-fray	Anti-fray
Branding	Single-sided sublimation	Single-sided sublimation	Single-sided sublimation
Range	★★ LEGEND RANGE	★★ LEGEND RANGE	★★ LEGEND RANGE
Refresh the banner for multiple campaigns by buying a new skin (SOLD IN SETS OF 2)			
Reskin Code	SKIN-7002	SKIN-7003	SKIN-7004

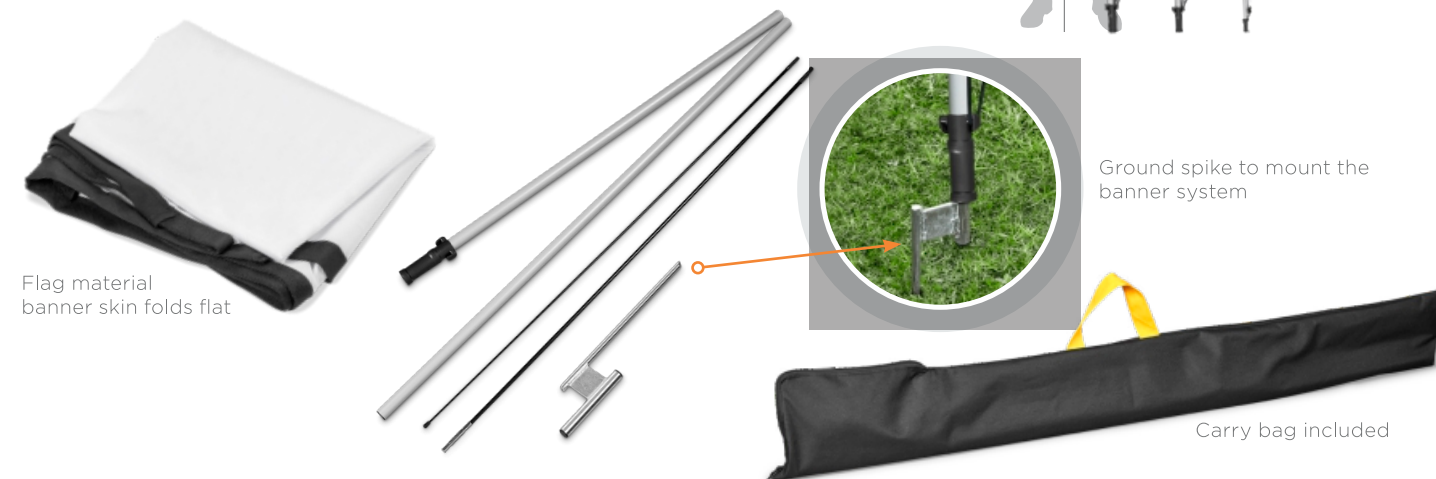
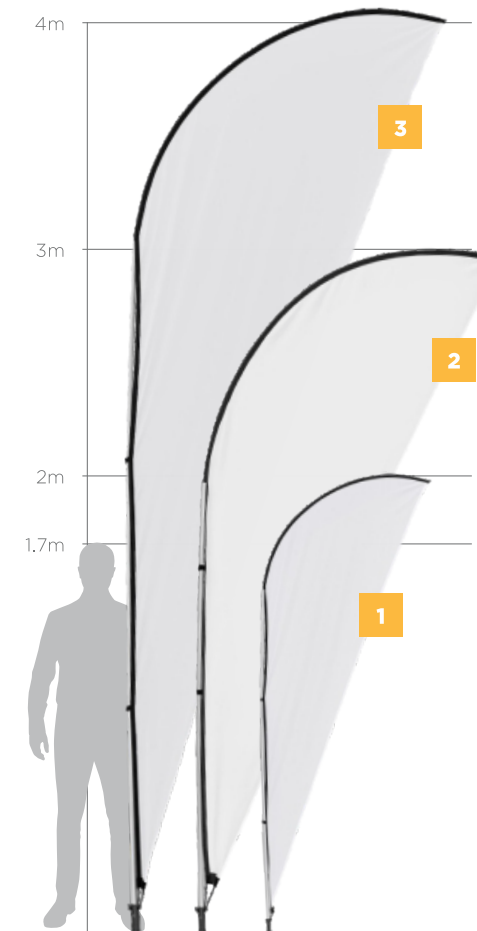

OPTIONAL EXTRAS FOR THE SHARKFIN FLYING BANNERS



DISPLAY-7000
LEGEND FLYING BANNER GROUND SPIKE
ground spike: steel

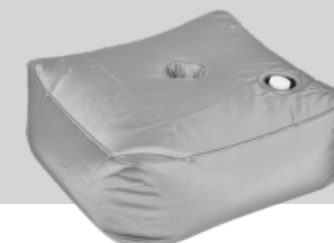

DISPLAY-7050
LEGEND FLYING BANNER 20L SQUARE WATER BASE
base: PP, refill with 20L water, collapsible



DISPLAY-7051
LEGEND FLYING BANNER SCISSOR BASE
base: steel, size: 60 x 60cm

DOUBLE-SIDED SHARKFIN FLYING BANNERS

	1 DISPLAY-7012	2 DISPLAY-7013	3 DISPLAY-7014
Weight	2kg	2.2kg	3.2kg
Hardware	2 x poles: aluminium	2 x poles: aluminium	3 x poles: aluminium
Frame assembled size	2m	3m	4m
Accessories	2 x rods: fibre 1 x ground spike: steel	2 x rods: fibre 1 x ground spike: steel	2 x rods: fibre 1 x ground spike: steel
Bag material	Polyester oxford	Polyester oxford	Polyester oxford
Bag size	137 x 18cm	137 x 18cm	137 x 18cm
Skin included	1 x banner skin	1 x banner skin	1 x banner skin
Material	Polyester warp knit	Polyester warp knit	Polyester warp knit
Visual size	0.98 x 2.24m	1.38 x 3.3m	1.14 x 4.4m
Features	Anti-fray	Anti-fray	Anti-fray
Branding	Double-sided sublimation	Double-sided sublimation	Double-sided sublimation
Range	★★ LEGEND RANGE	★★ LEGEND RANGE	★★ LEGEND RANGE
Refresh the banner for multiple campaigns by buying a new skin			
Reskin Code	SKIN-7012	SKIN-7013	SKIN-7014

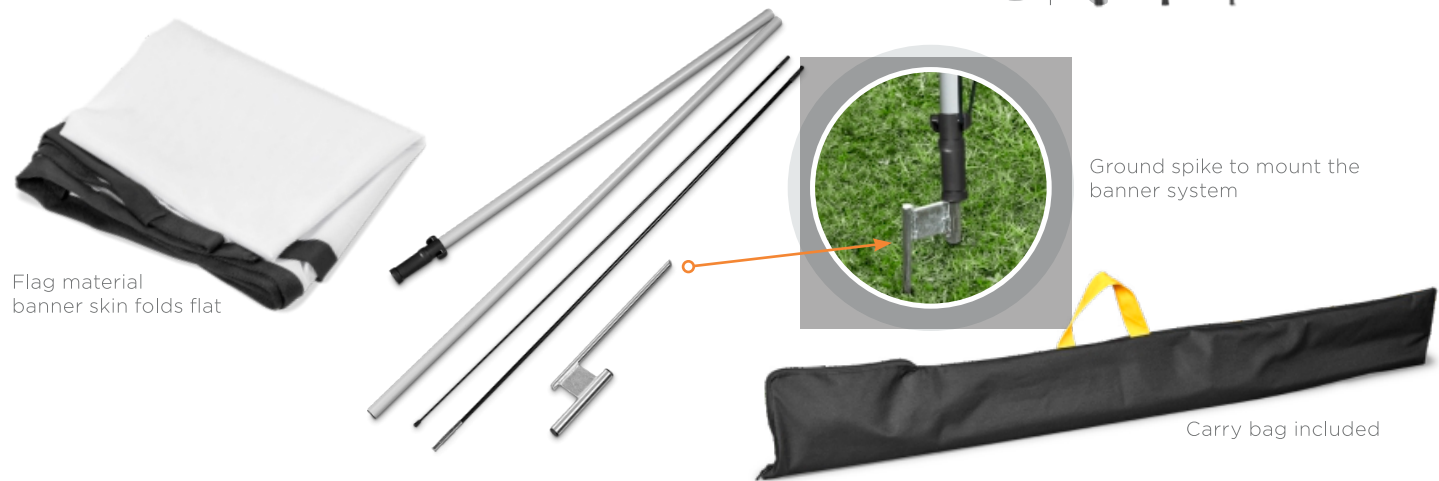
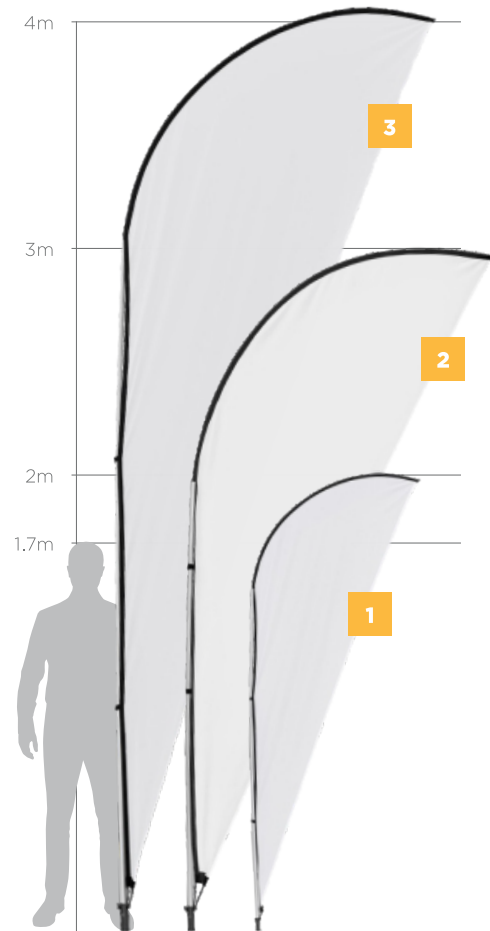

OPTIONAL EXTRAS FOR THE DOUBLE-SIDED SHARKFIN FLYING BANNERS



DISPLAY-7000

LEGEND FLYING BANNER GROUND SPIKE
ground spike: steel

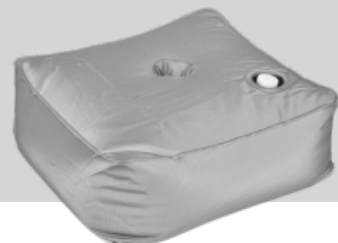

DISPLAY-7050

LEGEND FLYING BANNER 20L SQUARE WATER BASE
base: PP, refill with 20L water, collapsible



DISPLAY-7051

LEGEND FLYING BANNER SCISSOR BASE
base: steel, size: 60 x 60cm





TELESCOPIC FLYING BANNERS

	DISPLAY-7042	DISPLAY-7043	DISPLAY-7044
	Sold in sets of 2, info below is per unit		
Weight	1.8kg	2.7kg	3.5kg
Hardware	2 x poles & 1 arm: aluminium	3 x poles & 1 arm: aluminium	4 x poles & 1 arm: aluminium
Frame assembled size	2m	3m	4m
Accessories	1 x ground spike: steel	1 x ground spike: steel	1 x ground spike: steel
Bag material	Polyester oxford	Polyester oxford	Polyester oxford
Bag size	137 x 18cm	137 x 18cm	137 x 18cm
Skin included	1 x banner skin	1 x banner skin	1 x banner skin
Material	Polyester warp knit	Polyester warp knit	Polyester warp knit
Visual size	0.7 x 1.8m	0.7 x 2.5m	0.7 x 3.5m
Features	Anti-fray	Anti-fray	Anti-fray
Branding	Single-sided sublimation	Single-sided sublimation	Single-sided sublimation
Range	★★ LEGEND RANGE	★★ LEGEND RANGE	★★ LEGEND RANGE
Refresh the banner for multiple campaigns by buying a new skin (SOLD IN SETS OF 2)			
Reskin Code	SKIN-7042	SKIN-7043	SKIN-7044

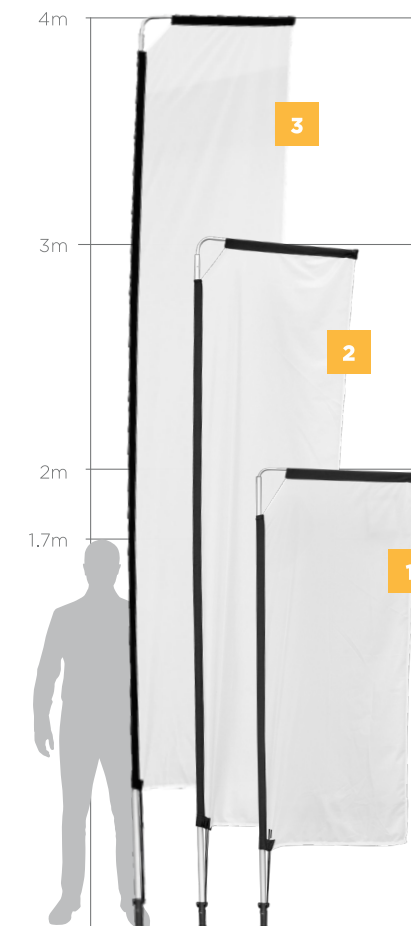

OPTIONAL EXTRAS FOR THE TELESCOPIC FLYING BANNERS



DISPLAY-7000
LEGEND FLYING BANNER GROUND SPIKE
ground spike: steel

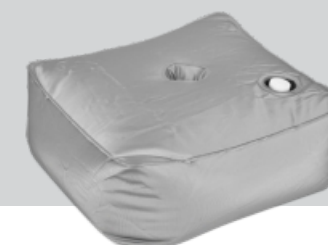

DISPLAY-7050
LEGEND FLYING BANNER 20L SQUARE WATER BASE
base: PP, refill with 20L water, collapsible



DISPLAY-7051
LEGEND FLYING BANNER SCISSOR BASE
base: steel, size: 60 x 60cm

DOUBLE-SIDED TELESCOPIC FLYING BANNERS

	DISPLAY-7052	DISPLAY-7053	DISPLAY-7054
Weight	2.1kg	2.4kg	4kg
Hardware	2 x poles & 1 arm: aluminium	3 x poles & 1 arm: aluminium	4 x poles & 1 arm: aluminium
Frame assembled size	2m	3m	4m
Accessories	1 x ground spike: steel	1 x ground spike: steel	1 x ground spike: steel
Bag material	Polyester oxford	Polyester oxford	Polyester oxford
Bag size	137 x 18cm	137 x 18cm	137 x 18cm
Skin included	1 x banner skin	1 x banner skin	1 x banner skin
Material	Polyester warp knit	Polyester warp knit	Polyester warp knit
Visual size	0.7 x 1.8m	0.7 x 2.5m	0.7 x 3.5m
Features	Anti-fray	Anti-fray	Anti-fray
Branding	Double-sided sublimation	Double-sided sublimation	Double-sided sublimation
Range	★★ LEGEND RANGE	★★ LEGEND RANGE	★★ LEGEND RANGE
Refresh the banner for multiple campaigns by buying a new skin			
Reskin Code	SKIN-7052	SKIN-7053	SKIN-7054

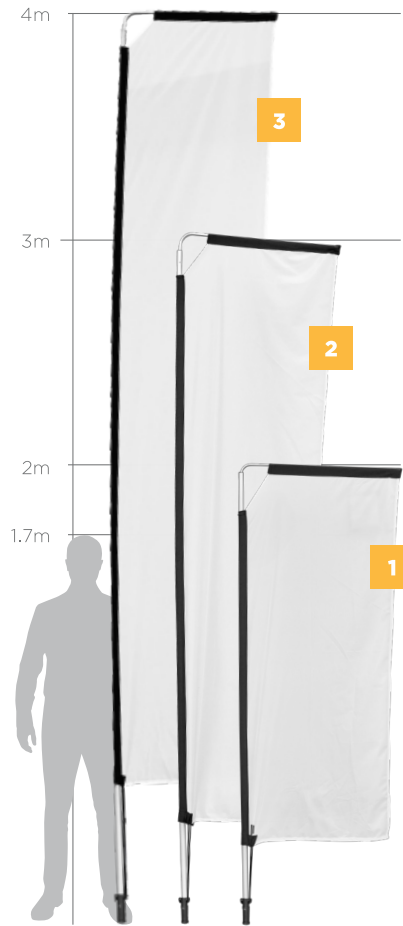

OPTIONAL EXTRAS FOR THE DOUBLE-SIDED TELESCOPIC FLYING BANNERS



A large blue parasol is the central focus, featuring a circular logo with a crown and the words 'BEER LIGHT' in gold and white. The parasol is set against a vibrant background of palm trees and a clear blue sky. A white, semi-transparent banner is overlaid on the left side of the image, containing text. In the top right corner, there is a yellow triangular graphic with two white stars.

SUBLIMATED PARASOLES

Create an inviting environment and overshadow your competition with our range of Parasols.

Ideal for restaurants, hotel courtyards, retail outlets and outdoor seating areas.

Our Parasols are manufactured with a sturdy aluminium frame and recycled plastic components to provide you with a high quality, corrosion resistant display solution.

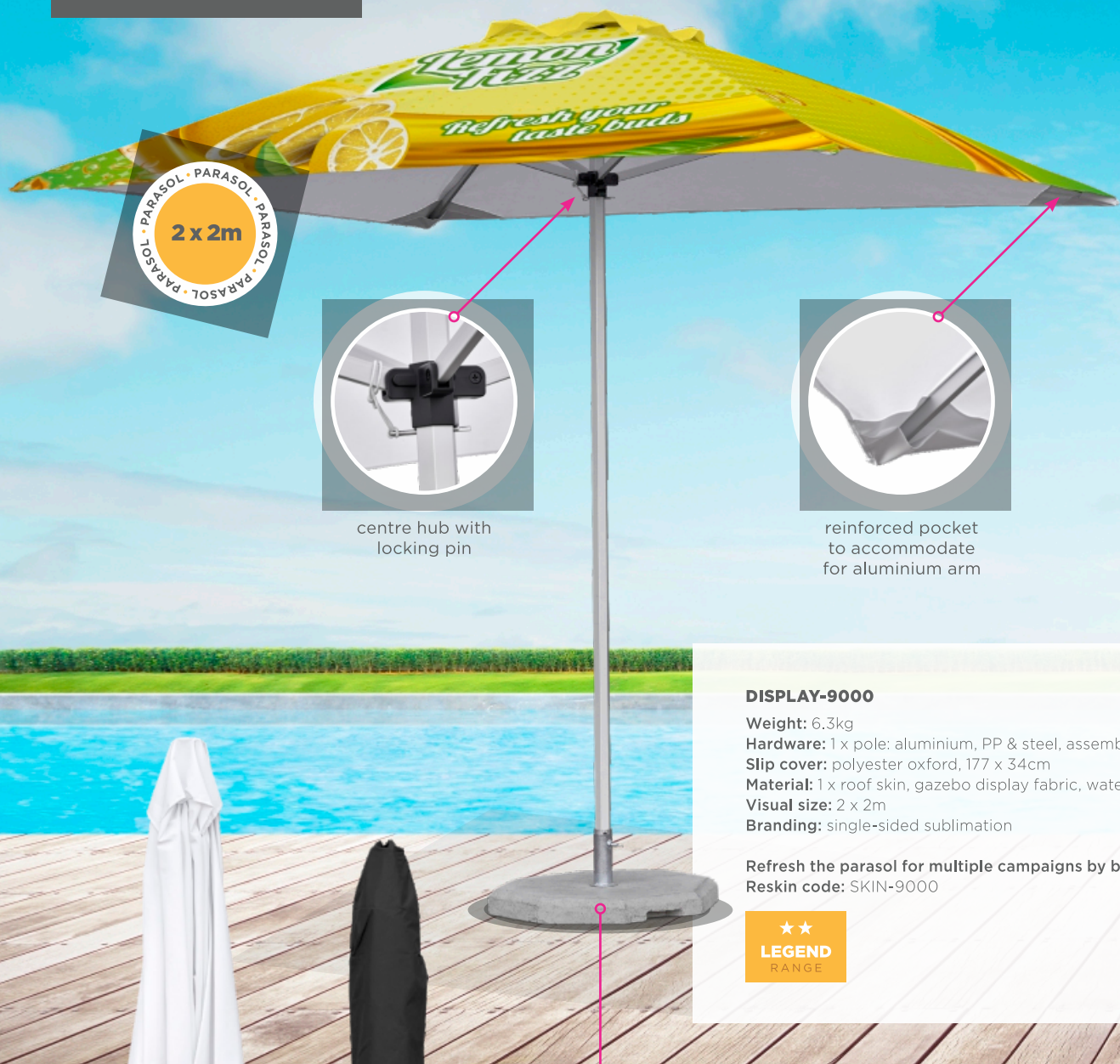

DISPLAY-9000
Weight: 6.3kg
Hardware: 1 x pole: aluminium, PP & steel, assembled size: 2 x 2m
Slip cover: polyester oxford, 177 x 34cm
Material: 1 x roof skin, gazebo display fabric, water-resistant
Visual size: 2 x 2m
Branding: single-sided sublimation

Refresh the parasol for multiple campaigns by buying a new skin
 Reskin code: SKIN-9000

★★
LEGEND
 RANGE

Parasol slip cover, also sold individually as DISBAG-9000

Base sold separately (see opposite page for details)

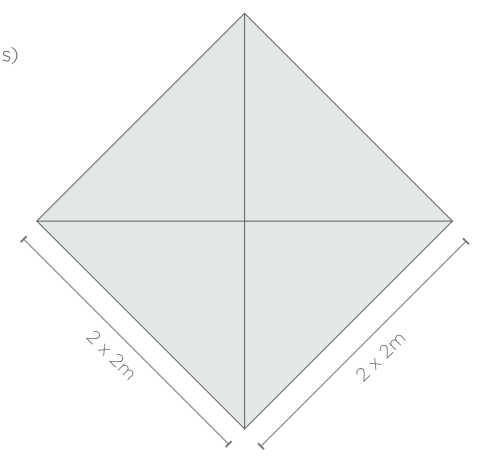

Parasol slip cover, also sold individually as DISBAG-9000



DISPLAY-9005
Weight: 6kg
Hardware: 1 x pole: aluminium, PP & steel, assembled size: 2 x 2m
 2m sliding pole, collapsible to 1.5m
Slip cover: polyester oxford, 177 x 34cm
Material: 1 x roof skin, gazebo display fabric, water-resistant
Visual size: 2 x 2m
Branding: single-sided sublimation

Refresh the parasol for multiple campaigns by buying a new skin
 Reskin code: SKIN-9000

★★
LEGEND
 RANGE

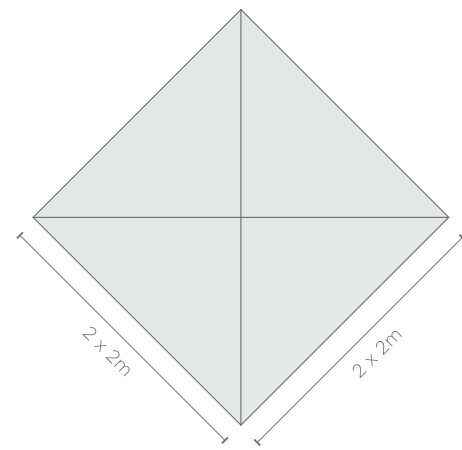

PARASOL BASE

DISPLAY-9001
PARASOL CONCRETE BASE
Weight: 28.75kg
Material: concrete & steel

Base sold separately and fits all 3 parasols:
 DISPLAY-9000, DISPLAY-9005, DISPLAY-9010



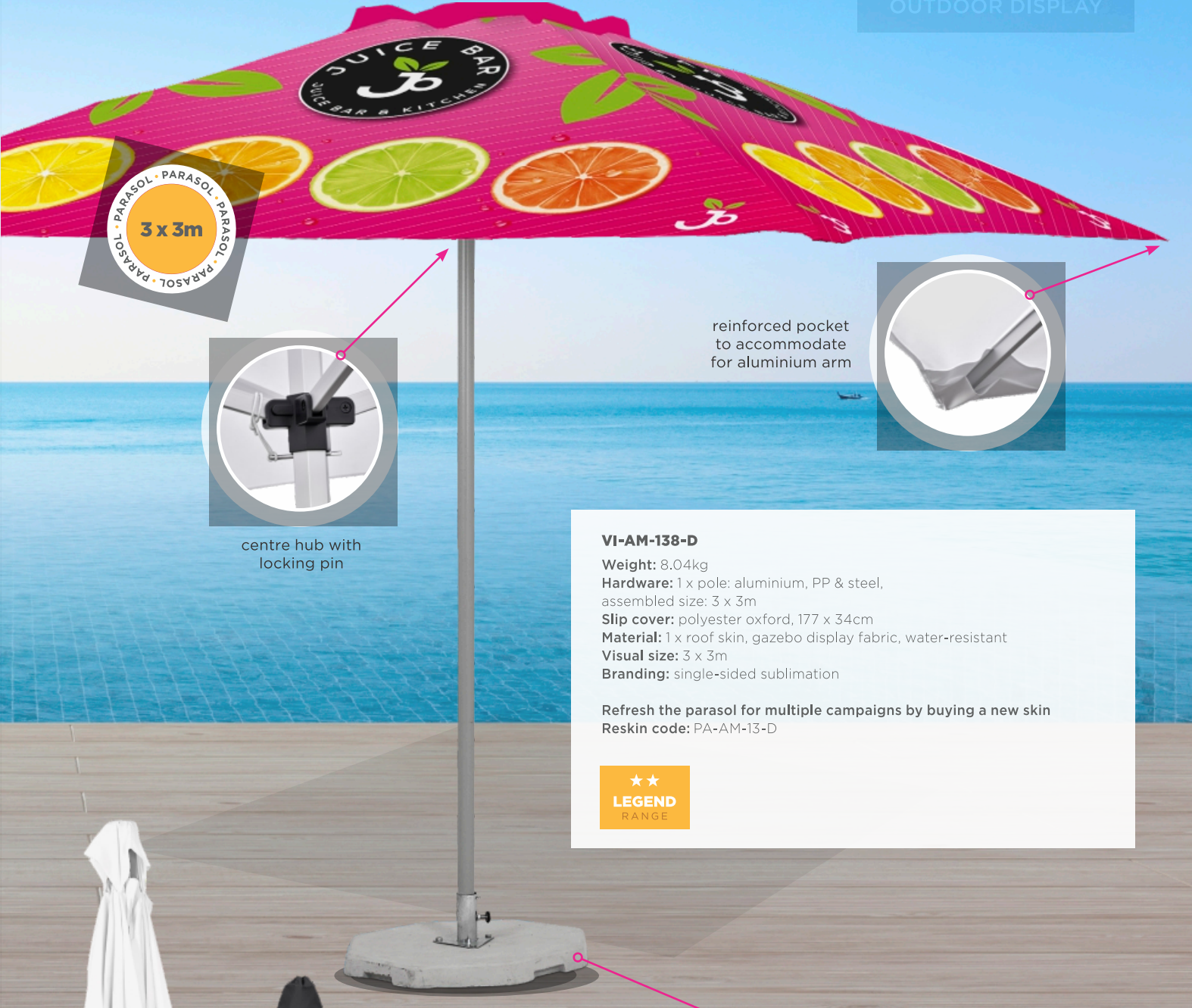

2.2m x 2.2m

3 x 3m



centre hub with locking pin



reinforced pocket to accommodate for aluminium arm

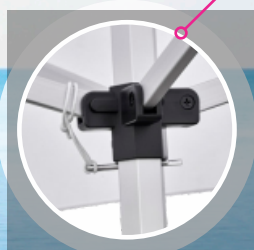

centre hub with locking pin



reinforced pocket to accommodate for aluminium arm



Parasol slip cover, also sold individually as DISBAG-9000

VI-AM-138-D
Weight: 8.04kg
Hardware: 1 x pole: aluminium, PP & steel, assembled size: 3 x 3m
Slip cover: polyester oxford, 177 x 34cm
Material: 1 x roof skin, gazebo display fabric, water-resistant
Visual size: 3 x 3m
Branding: single-sided sublimation

Refresh the parasol for multiple campaigns by buying a new skin
 Reskin code: PA-AM-13-D

★★
LEGEND
 RANGE

DISPLAY-9010

Weight: 7.12kg
Hardware: 1 x pole: aluminium, PP & steel, assembled size: 2.2 x 2.2m
Slip cover: polyester oxford, 177 x 34cm
Material: 1 x roof skin, gazebo display fabric, water-resistant
Visual size: 2.2 x 2.2m
Branding: single-sided sublimation

Refresh the parasol for multiple campaigns by buying a new skin
 Reskin code: SKIN-9010

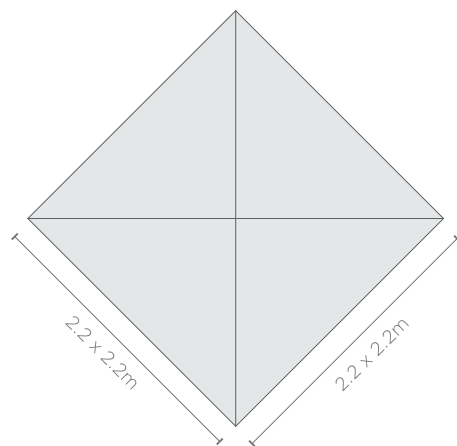

PARASOL BASE

DISPLAY-9001
PARASOL CONCRETE BASE
Weight: 28.75kg
Material: concrete & steel

Base sold separately and fits all 3 parasols:
 DISPLAY-9000, DISPLAY-9005, DISPLAY-9010



PARASOL BASE

PA-AM-16-D
PARASOL CONCRETE BASE
Weight: 50.00kg
Material: concrete & steel

Base sold separately and fits:
 VI-AM-137-D, VI-AM-138-D

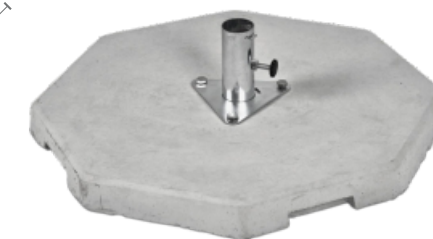

Parasol slip cover, also sold individually as PA-AM-12-D

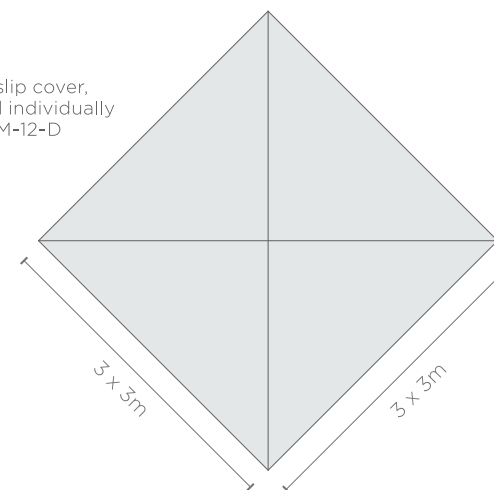



FADE RESISTANT PARASOLES

Our Fade Resistant Displays are printed with state-of-the-art Latex Gen-4 inks, boasting the widest colour gamut on the market.

This allows us to print the widest range of colours within the colour spectrum and produce the most vibrant and vivid print results.

The inks have a low environmental impact, are UV stable and scratch resistant, providing great durability for long-term outdoor exposure.

Premium polyester fabric with a unique print-guard coating is used for all of our Fade Resistant Parasoles.

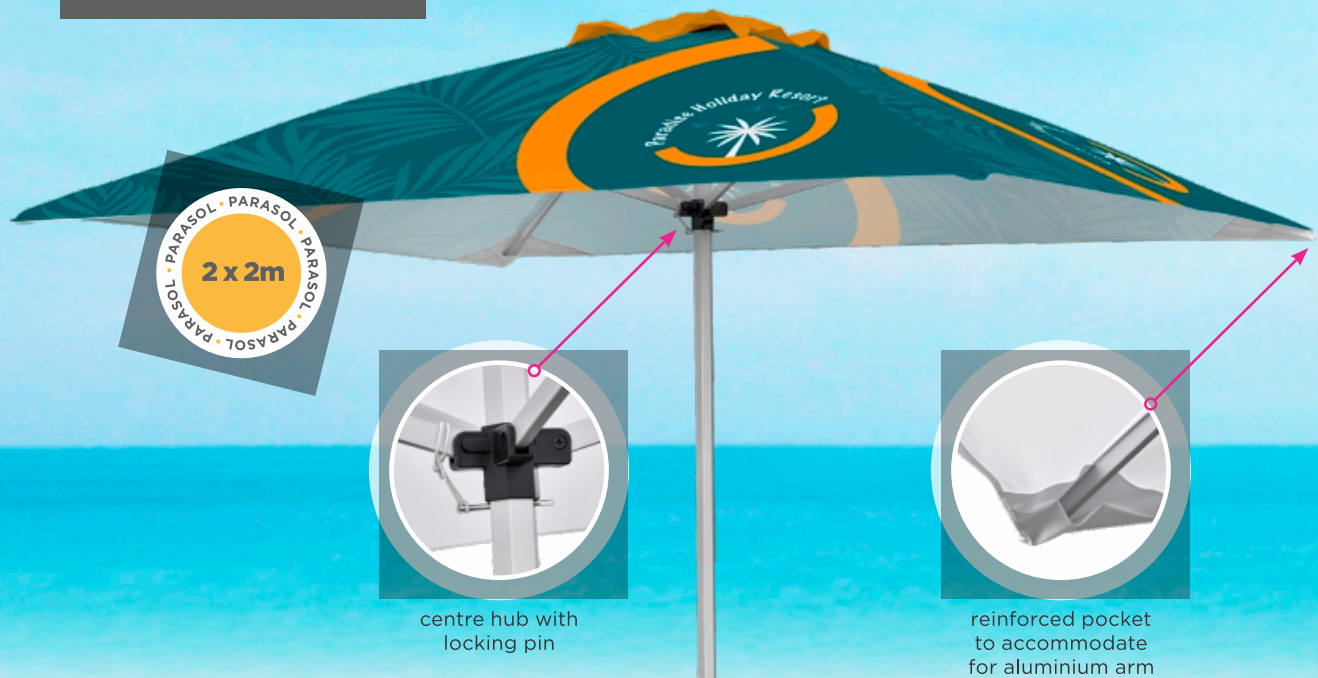

VI-AM-139-D
Weight: 6.3kg
Hardware: 1 x pole: aluminium, PP & steel, assembled size: 2 x 2m
Slip cover: polyester oxford, 177 x 34cm
Material: print-guard polyester, water resistant
Visual size: 2 x 2m
Branding: latex gen-4 printing

Refresh the parasol for multiple campaigns by buying a new skin
 Reskin code: PA-AM-14-D

★★★
OVATION
 RANGE



Base sold separately
 (see opposite page for details)

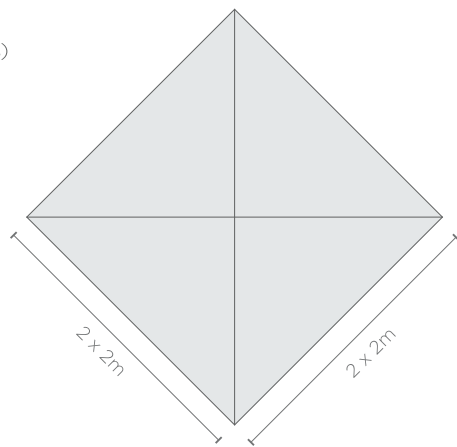

Parasol slip cover, also sold individually as DISBAG-9000

VI-AM-140-D

Weight: 6kg
Hardware: 1 x pole: aluminium, PP & steel, assembled size: 2 x 2m, 2m sliding pole, collapsible to 1.5m
Slip cover: polyester oxford, 177 x 34cm
Material: print-guard polyester, water resistant
Visual size: 2 x 2m
Branding: latex gen-4 printing

Refresh the parasol for multiple campaigns
 by buying a new skin
 Reskin code: PA-AM-14-D

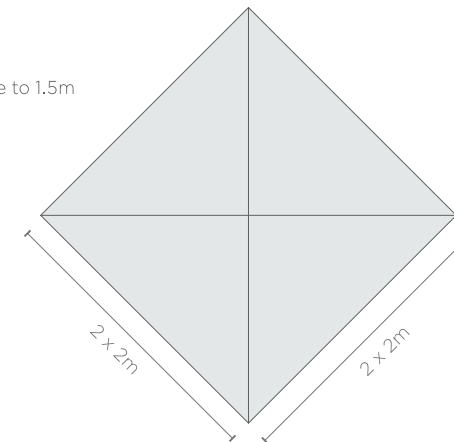

PARASOL BASE

DISPLAY-9001
PARASOL CONCRETE BASE
Weight: 28.75kg
Material: concrete & steel

Base sold separately and fits all 3 parasols:
 VI-AM-139-D, VI-AM-140-D, VI-AM-141-D

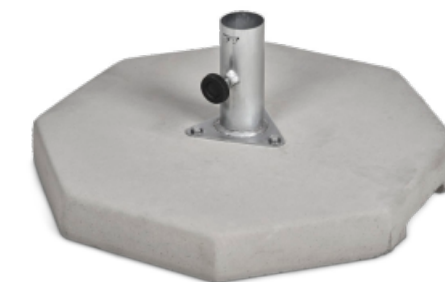



VI-AM-137-D
Weight: 8.14kg
Hardware: 1 x pole: aluminium, PP & steel, assembled size: 3 x 3m
Slip cover: polyester oxford, 177 x 34cm
Material: print-guard polyester, water resistant
Visual size: 3 x 3m
Branding: latex gen-4 printing

Refresh the parasol for multiple campaigns by buying a new skin
 Reskin code: PA-AM-10-D

★★★
OVATION
 RANGE

Parasol slip cover, also sold individually as DISBAG-9000

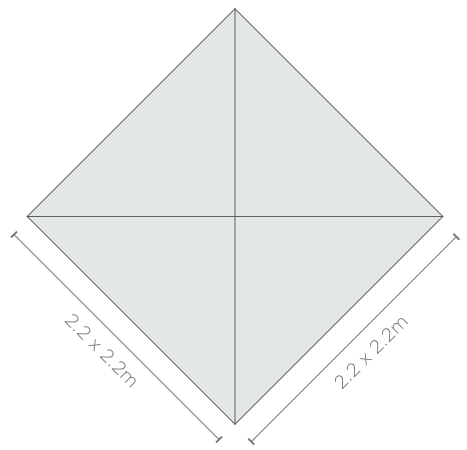

PARASOL BASE

DISPLAY-9001
PARASOL CONCRETE BASE
Weight: 28.75kg
Material: concrete & steel

Base sold separately and fits all 3 parasols:
 VI-AM-139-D, VI-AM-140-D, VI-AM-141-D



VI-AM-141-D
Weight: 7.12kg
Hardware: 1 x pole: aluminium, PP & steel, assembled size: 2.2 x 2.2m
Slip cover: polyester oxford, 177 x 34cm
Material: print-guard polyester, water resistant
Visual size: 2.2 x 2.2m
Branding: latex gen-4 printing

Refresh the parasol for multiple campaigns by buying a new skin
 Reskin code: PA-AM-15-D

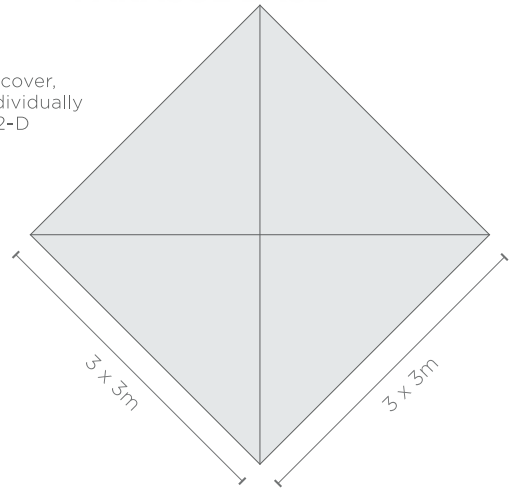

PARASOL BASE

PA-AM-16-D
PARASOL CONCRETE BASE
Weight: 50.00kg
Material: concrete & steel

Base sold separately and fits:
 VI-AM-137-D, VI-AM-138-D

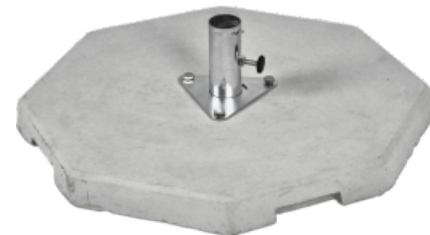



SUBLIMATED GAZEBOS

Gazebos are suitable for brand activations, product launches, markets, sporting events, marathons, schools, festivals, golf days and so much more.

All of our Gazebos fall within the Ovation family - defined by premium quality construction and durability, at an extremely competitive price point.

Available in a range of popular sizes our standard Gazebos include the following components:

- 1 x durable and lightweight aluminium frame
- 1 x water-resistant polyester roof
- 1 x polyester carry bag for portability and convenient storage.

CUSTOMISE YOUR GAZEBO

Half and Full Wall Skins are available for all of the Gazebos in this range - allowing you to customise and configure your Gazebo to suit your requirements and maximise your brand exposure. The wall skins easily attach to the structure, making this display solution ideal for interchangeable artwork - offering a great ROI for your business.

The wall skins are branded on one side only, using our state-of-the-art sublimation branding process to produce vibrant results.



SUBLIMATED GAZEBO 1 X 1M KIOSK

SPECIFICATIONS

Weight: 11kg

Hardware: 1 x frame: aluminium, assembled size: 1 x 1m, quick assembly, portable

Table: ABS top with aluminium supports 100 x 29 x 3cm

Bag included: polyester oxford, size: 123 x 18 x 18cm

Fabric: gazebo display fabric, fitted 600D water head, water resistant

Branding: single-sided sublimation

Half wall visual size: 1 x 1m

Full wall visual size: 1 x 1.9m



WALL CONFIGURATION	DISPLAY CODE
No walls	DISPLAY-2000
1 x half wall skin	DISPLAY-2002
3 x half wall skins	DISPLAY-2004
3 x half wall skins, 1 x full wall skin	DISPLAY-2006

Refresh the gazebo for multiple campaigns by buying a new skin	
Roof Reskin Code	SKIN-2000
Full Wall Reskin Code	SKIN-2002
Half Wall Reskin Code	SKIN-2004

The compact design and flat roof structure makes this gazebo perfect for indoor and outdoor activations that require quick setups and lend themselves to promotions and brand activations in forecourts and other small areas.



4 attached loops for additional stability, used to secure gazebo with ground pegs and ropes (not included) see TOOLKIT-2000



Mobile kiosk includes ABS tabletop with aluminium supports



Aluminium hexagonal leg profile for superior strength & pre-punched feet to easily secure gazebo with ground pegs

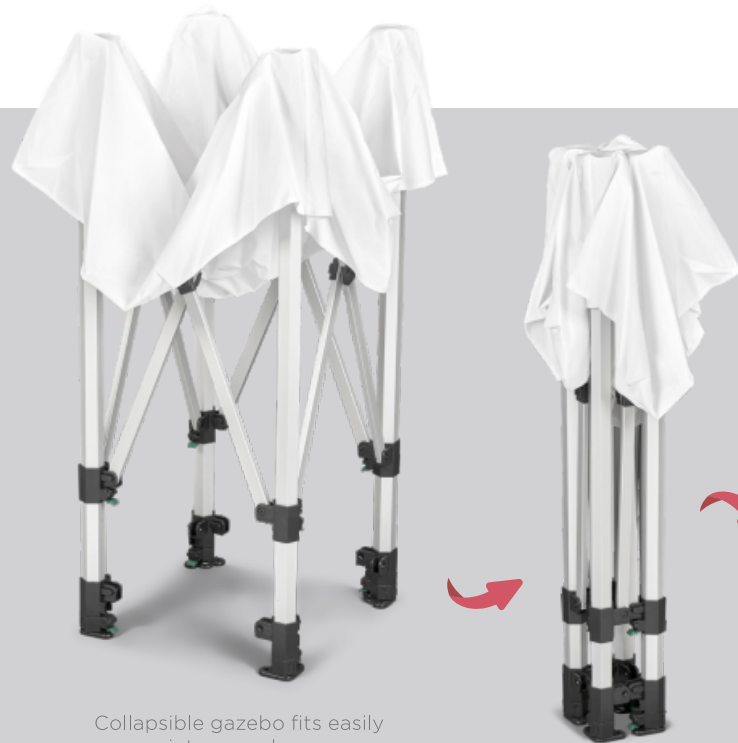

Collapsible gazebo fits easily into carry bag



Carry bag included



Images shown are for DISPLAY-2004

Branding is visible on one side only, walls can face inwards (A) or outwards (B)

SUBLIMATED GAZEBO 1.5 X 1.5M KIOSK

SPECIFICATIONS

- Weight:** 8kg
- Hardware:** 1 x frame: aluminium, assembled size: 1.5 x 1.5m, quick assembly, portable
- Bag included:** polyester oxford, size: 156 x 23 x 21cm, webbing handles
- Toolkit included:** 1 x mallet: rubber & wood, 4 x ropes: nylon, 4 x frame pegs: steel, 4 x rope pegs: steel
- Fabric:** gazebo display fabric, fitted 600D water head, water resistant
- Branding:** single-sided sublimation
- Half wall visual size:** 1.5 x 1m
- Full wall visual size:** 1.5 x 1.9m



WALL CONFIGURATION	DISPLAY CODE
No walls	DISPLAY-2020
1 x full wall skin	DISPLAY-2022
2 x full wall skins	DISPLAY-2024
3 x full wall skins	DISPLAY-2026
1 x half wall skin	DISPLAY-2028
2 x half wall skins	DISPLAY-2030
3 x half wall skins	DISPLAY-2032
4 x half wall skins	DISPLAY-2034
1 x half wall skin, 1 x full wall skin	DISPLAY-2035
2 x half wall skins, 1 x full wall skin	DISPLAY-2036
3 x half wall skins, 1 x full wall skin	DISPLAY-2038

Refresh the gazebo for multiple campaigns by buying a new skin	
Roof Reskin Code	SKIN-2020
Full Wall Reskin Code	SKIN-2022
Half Wall Reskin Code	SKIN-2024

The compact design and flat roof structure makes this gazebo perfect for indoor and outdoor activations that require quick setups and lend themselves to promotions and brand activations in forecourts and other small areas.



4 attached loops for additional stability, used to secure gazebo with ground pegs and ropes



Aluminium hexagonal leg profile for superior strength



Pre-punched feet to easily secure gazebo with ground pegs



Branding is visible on one side only, walls can face inwards (A) or outwards (B)

Images shown are for DISPLAY-2036

GAZEBO FOOTPRINT

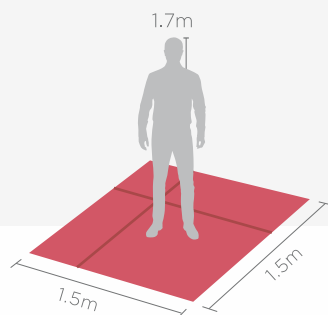

Collapsible gazebo fits easily into carry bag



Carry bag included
(ALSO SOLD INDIVIDUALLY AS DISBAG-2020)



Toolkit included: 1 x mallet, 4 x ropes, 4 x frame pegs, 4 x rope pegs
(ALSO SOLD INDIVIDUALLY AS TOOLKIT-2000)

SUBLIMATED GAZEBO
2 X 2M

SPECIFICATIONS

Weight: 14kg
Hardware: 1 x frame: aluminium, assembled size: 2 x 2m, quick assembly, portable
Slip over bag included: polyester oxford, size: 158 x 28 x 28cm, webbing handles
Toolkit included: 1 x mallet: rubber & wood, 4 x ropes: nylon, 4 x frame pegs: steel, 4 x rope pegs: steel
Fabric: gazebo display fabric, fitted 600D water head, water resistant
Branding: single-sided sublimation
Half wall visual size: 2 x 1m
Full wall visual size: 2 x 1.9m



WALL CONFIGURATION	DISPLAY CODE
No walls	DISPLAY-2040
1 x full wall skin	DISPLAY-2042
2 x full wall skins	DISPLAY-2044
3 x full wall skins	DISPLAY-2045
1 x half wall skin	DISPLAY-2046
2 x half wall skins	DISPLAY-2048
3 x half wall skins	DISPLAY-2050
4 x half wall skins	DISPLAY-2052
1 x full wall skin, 1 x half wall skin	DISPLAY-2054
1 x full wall skin, 2 x half wall skins	DISPLAY-2056
1 x full wall skin, 3 x half wall skins	DISPLAY-2058

Refresh the gazebo for multiple campaigns by buying a new skin	
Roof Reskin Code	SKIN-2040
Full Wall Reskin Code	SKIN-2042
Half Wall Reskin Code	SKIN-2044

Pitched roof gazebo, perfect for outdoor events and activations where a smaller footprint is required.



4 attached loops for additional stability, used to secure gazebo with ground pegs and ropes

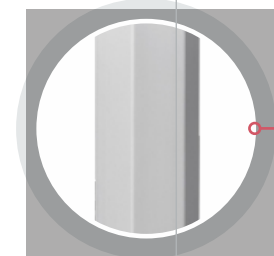

Aluminium hexagonal leg profile for superior strength



Pre-punched feet to easily secure gazebo with ground pegs



Toolkit included: 1 x mallet, 4 x ropes, 4 x frame pegs, 4 x rope pegs

(ALSO SOLD INDIVIDUALLY AS TOOLKIT-2000)



Collapsible gazebo fits easily into carry bag

Slip over bag included
(ALSO SOLD INDIVIDUALLY AS DISBAG-2040)



BAG ON WHEELS FOR 2m GAZEBO
SOLD INDIVIDUALLY AS DISPLAY-2001

GAZEBO FOOTPRINT

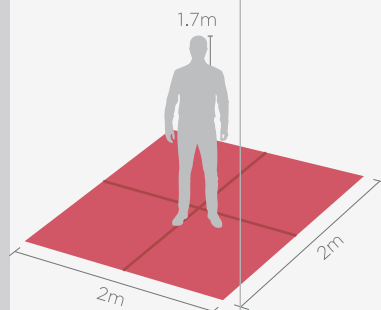

Image shown is for DISPLAY-2052

Branding is visible on one side only, walls can face inwards or outwards

SUBLIMATED GAZEBO 2 X 2M - PETITE FRAME

SPECIFICATIONS

- Weight:** 13kg
- Hardware:** 1 x frame: aluminium, assembled size: 2 x 2m, quick assembly, portable, compact
- Slip over bag included:** polyester oxford, size: 122 x 28 x 28cm, webbing handles
- Toolkit included:** 1 x mallet: rubber & wood, 4 x ropes: nylon, 4 x frame pegs: steel, 4 x rope pegs: steel
- Fabric:** gazebo display fabric, fitted 600D water head, water resistant
- Branding:** single-sided sublimation
- Half wall visual size:** 2 x 1m
- Full wall visual size:** 2 x 1.85m



WALL CONFIGURATION	DISPLAY CODE
No walls	DISPLAY-2140
1 x full wall skin	DISPLAY-2142
2 x full wall skins	DISPLAY-2144
3 x full wall skins	DISPLAY-2145
1 x half wall skin	DISPLAY-2146
2 x half wall skins	DISPLAY-2148
3 x half wall skins	DISPLAY-2150
4 x half wall skins	DISPLAY-2152
1 x half wall skin, 1 x full wall skin	DISPLAY-2154
2 x half wall skins, 1 x full wall skin	DISPLAY-2156
3 x half wall skins, 1 x full wall skin	DISPLAY-2158

Refresh the gazebo for multiple campaigns by buying a new skin	
Roof Reskin Code	SKIN-2040
Full Wall Reskin Code	SKIN-2140
Half Wall Reskin Code	SKIN-2044

This gazebo is perfect for brand activations, product launches, sporting events and mobile retail shops to mention a few. The Petite Gazebo features extra collapsible legs that slide in making it compact and portable allowing for easy transportation.



4 attached loops for additional stability, used to secure gazebo with ground pegs and ropes

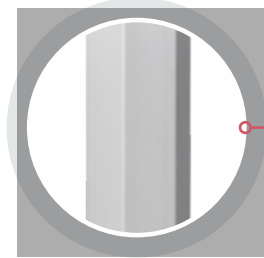

Aluminium hexagonal leg profile for superior strength



Pre-punched feet to easily secure gazebo with ground pegs



GAZEBO FOOTPRINT

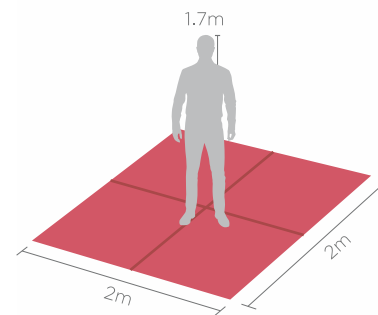

Collapsible gazebo fits easily into carry bag



Slip over bag included
(ALSO SOLD INDIVIDUALLY AS DISBAG-2140)



Toolkit included: 1 x mallet, 4 x ropes, 4 x frame pegs, 4 x rope pegs
(ALSO SOLD INDIVIDUALLY AS TOOLKIT-2000)

Image shown is for DISPLAY-2156

Branding is visible on one side only, walls can face inwards or outwards

SUBLIMATED GAZEBO 3 X 3M

SPECIFICATIONS

- Weight:** 19kg
- Hardware:** 1 x frame: aluminium, assembled size: 3 x 3m, quick assembly, portable
- Slip over bag included:** polyester oxford, size: 158 x 28 x 28cm, webbing handles
- Toolkit Included:** 1 x mallet: rubber & wood, 4 x ropes: nylon, 4 x frame pegs: steel, 4 x rope pegs: steel
- Fabric:** gazebo display fabric, fitted 600D water head, water resistant
- Branding:** single-sided sublimation
- Half wall visual size:** 3 x 1m
- Full wall visual size:** 3 x 1.9m



WALL CONFIGURATION	DISPLAY CODE
No walls	DISPLAY-2060
1 x full wall skin	DISPLAY-2062
2 x full wall skins	DISPLAY-2064
3 x full wall skins	DISPLAY-2065
1 x half wall skin	DISPLAY-2066
2 x half wall skins	DISPLAY-2068
3 x half wall skins	DISPLAY-2070
4 x half wall skins	DISPLAY-2072
1 x half wall skin, 1 x full wall skin	DISPLAY-2074
2 x half wall skins, 1 x full wall skin	DISPLAY-2076
3 x half wall skins, 1 x full wall skin	DISPLAY-2078

Refresh the gazebo for multiple campaigns by buying a new skin	
Roof Reskin Code	SKIN-2060
Full Wall Reskin Code	SKIN-2062
Half Wall Reskin Code	SKIN-2064

With a slightly bigger footprint, this gazebo size is ideal for brand activations, product launches, sporting events and mobile retail to mention a few.

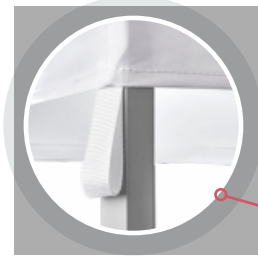

4 attached loops for additional stability, used to secure gazebo with ground pegs and ropes

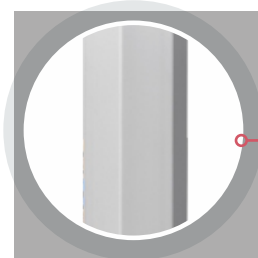

Aluminium hexagonal leg profile for superior strength



Pre-punched feet to easily secure gazebo with ground pegs



Image shown is for DISPLAY-2065

Branding is visible on one side only, walls can face inwards or outwards

GAZEBO FOOTPRINT

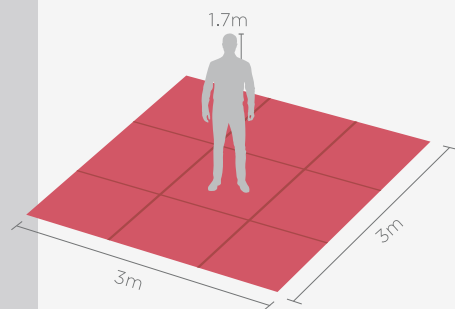

Collapsible gazebo fits easily into carry bag



Slip over bag included

(ALSO SOLD INDIVIDUALLY AS DISBAG-2040)



Toolkit included: 1 x mallet, 4 x ropes, 4 x frame pegs, 4 x rope pegs

(ALSO SOLD INDIVIDUALLY AS TOOLKIT-2000)



BAG ON WHEELS FOR 3m GAZEBO SOLD INDIVIDUALLY AS DISPLAY-2001

SUBLIMATED GAZEBO
4.5 X 3M

SPECIFICATIONS

- Weight:** 25kg
- Hardware:** 1 x frame: aluminium, assembled size: 4.5 x 3m, quick assembly, portable
- Slip over bag included:** polyester oxford, size: 158 x 29 x 31cm, webbing handles
- Toolkit included:** 1 x mallet: rubber & wood, 4 x ropes: nylon, 4 x frame pegs: steel, 4 x rope pegs: steel
- Fabric:** gazebo display fabric, fitted 600D water head, water resistant
- Branding:** single-sided sublimation
- Short half wall visual size:** 3 x 1m
- Long full wall visual size:** 4.5 x 1.9m
- Short full wall visual size:** 3 x 1.9m



WALL CONFIGURATION	DISPLAY CODE
No walls	DISPLAY-2080
1 x long full wall skin	DISPLAY-2082
2 x long full wall skins	DISPLAY-2084
1 x long full wall skin, 1 x short full wall skin	DISPLAY-2085
1 x long full wall skin, 2 x short half wall skins	DISPLAY-2086
1 x short full wall skin	DISPLAY-2088
2 x short full wall skins	DISPLAY-2090
2 x short half wall skins	DISPLAY-2092
1 x short half wall skin, 1 x long full wall skin	DISPLAY-2094

Refresh the gazebo for multiple campaigns by buying a new skin	
Roof Reskin Code	SKIN-2080
Long Full Wall Reskin Code	SKIN-2082
Short Full Wall Reskin Code	SKIN-2085
Short Half Wall Reskin Code	SKIN-2084

GAZEBO FOOTPRINT

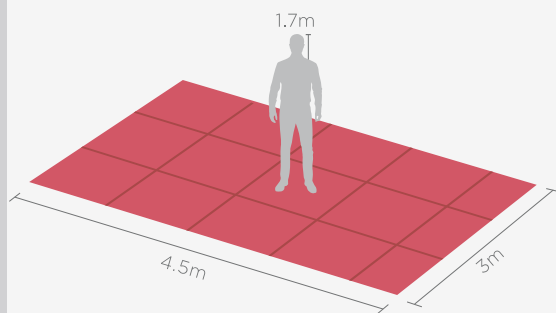

This gazebo has a slightly bigger footprint, accommodating for extra retail or display space. Perfectly fits 2 trestle tables under roof and big enough to fit 1 vehicle. That extra space might come in handy depending on the activation, product launch or event at hand.



4 attached loops for additional stability, used to secure gazebo with ground pegs and ropes



Collapsible gazebo fits easily into carry bag



Slip over bag included
(ALSO SOLD INDIVIDUALLY AS DISBAG-2080)

Toolkit included: 1 x mallet, 4 x ropes, 4 x frame pegs, 4 x rope pegs

(ALSO SOLD INDIVIDUALLY AS TOOLKIT-2000)

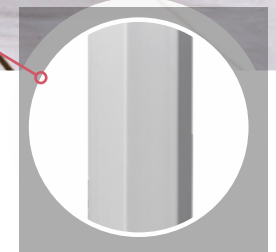

Aluminium hexagonal leg profile for superior strength



Pre-punched feet to easily secure gazebo with ground pegs

Image shown is for DISPLAY-2085

Branding is visible on one side only, walls can face inwards or outwards

SUBLIMATED GAZEBO
6 X 3M

SPECIFICATIONS

- Weight:** 32kg
- Hardware:** 1 x frame: aluminium, assembled size: 6 x 3m, quick assembly, portable
- Bag included:** polyester oxford, size: 158 x 28 x 43cm, webbing handles
- Toolkit Included:** 1 x mallet: rubber & wood, 6 x ropes: nylon, 6 x frame pegs: steel, 4 x rope pegs: steel
- Fabric:** gazebo display fabric, fitted 600D water head, water resistant
- Branding:** single-sided sublimation
- Short half wall visual size:** 3 x 1m
- Long full wall visual size:** 6 x 1.9m
- Short full wall visual size:** 3 x 1.9m



WALL CONFIGURATION	DISPLAY CODE
No walls	DISPLAY-2010
1 x long full wall skin	DISPLAY-2011
2 x long full wall skins	DISPLAY-2012
1 x long full wall skin, 1 x short full wall skin	DISPLAY-2013
1 x long full wall skin, 2 x short half wall skins	DISPLAY-2014
1 x short full wall skin	DISPLAY-2015
2 x short full wall skins	DISPLAY-2016
2 x short half wall skins	DISPLAY-2017
1 x short half wall skin, 1 x long full wall skin	DISPLAY-2018

Refresh the gazebo for multiple campaigns by buying a new skin	
Roof Reskin Code	SKIN-2010
Long Full Wall Reskin Code	SKIN-2012
Short Full Wall Reskin Code	SKIN-2015
Short Half Wall Reskin Code	SKIN-2014

GAZEBO FOOTPRINT

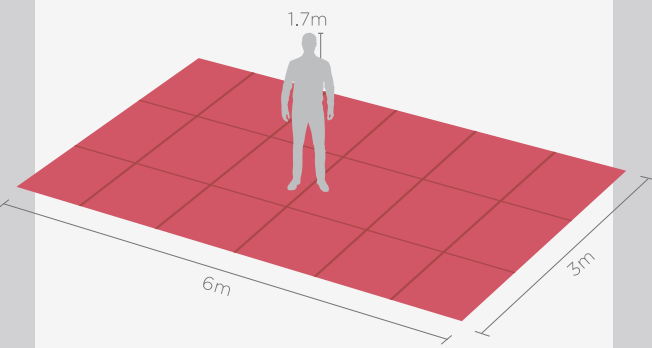

Collapsible gazebo fits easily into carry bag



From outdoor events to corporate functions, this lightweight gazebo is the perfect display solution. It is fully collapsible and easy to setup, not mention fully customisable in terms of the number of walls and branding options. Branded Gazebos are a popular and affordable means of advertising.



4 attached ropes for additional stability, used to secure gazebo with ground pegs and ropes

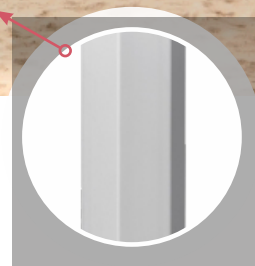

Aluminium hexagonal leg profile for superior strength



Pre-punched feet to easily secure gazebo with ground pegs

Image shown is for DISPLAY-2011

Branding is visible on one side only, walls can face inwards or outwards



FADE RESISTANT GAZEBOS

Our Fade Resistant Displays are printed with state-of-the-art Latex Gen-4 inks, boasting the widest colour gamut on the market.

This allows us to print the widest range of colours within the colour spectrum and produce the most vibrant and vivid print results.

The inks have a low environmental impact, are UV stable and scratch resistant, providing great durability for long-term outdoor exposure.

Premium polyester fabric with a unique print-guard coating is used for all of our Fade Resistant Gazebos.



FADE RESISTANT GAZEBO 1 X 1M KIOSK

SPECIFICATIONS

Weight: 11kg
Hardware: 1 x frame: aluminium, assembled size: 1 x 1m, quick assembly, portable
Table: ABS top with aluminium supports 100 x 29 x 3cm
Bag included: polyester oxford, size: 123 x 18 x 18cm
Fabric: print-guard polyester, water resistant
Branding: single-sided, latex gen-4 printing
Half wall visual size: 1 x 1m
Full wall visual size: 1 x 1.9m



WALL CONFIGURATION	DISPLAY CODE
No walls	VI-AM-142-D
1 x half wall skin	VI-AM-143-D
3 x half wall skins	VI-AM-144-D
3 x half wall skins, 1 x full wall skin	VI-AM-145-D

Refresh the gazebo for multiple campaigns by buying a new skin	
Roof Reskin Code	GZ-AM-38-D
Full Wall Reskin Code	GZ-AM-40-D
Half Wall Reskin Code	GZ-AM-39-D

The compact design and flat roof structure makes this gazebo perfect for indoor and outdoor activations that require quick setups and lend themselves to promotions and brand activations in forecourts and other small areas.



4 attached loops for additional stability, used to secure gazebo with ground pegs and ropes (not included) see TOOLKIT-2000



Mobile kiosk includes ABS tabletop with aluminium supports



Aluminium hexagonal leg profile for superior strength & pre-punched feet to easily secure gazebo with ground pegs

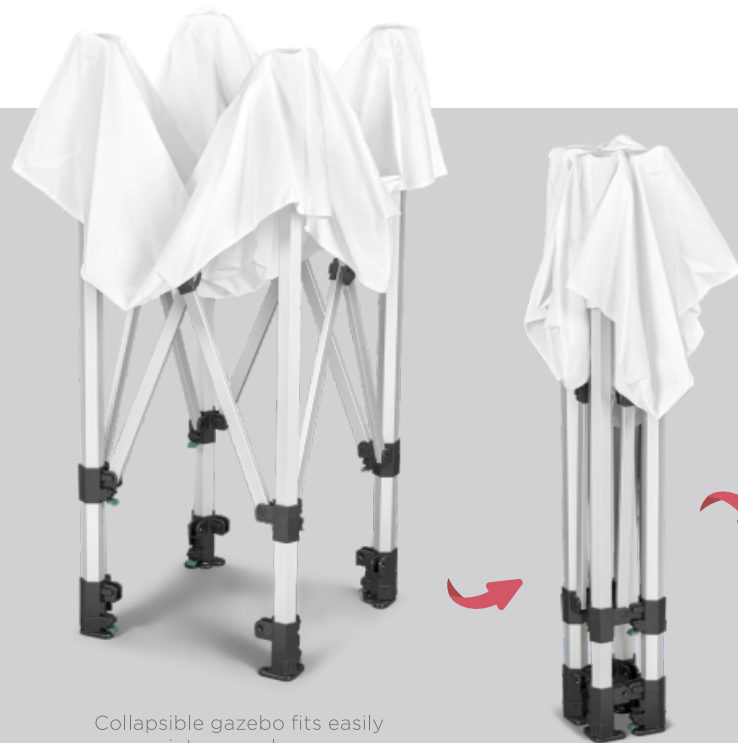

Collapsible gazebo fits easily into carry bag



Carry bag included



GAZEBO FOOTPRINT

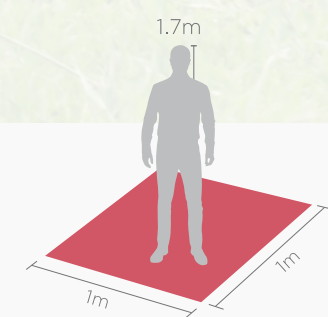

Images shown are for VI-AM-144-D

Branding is visible on one side only, walls can face inwards (A) or outwards (B)

FADE RESISTANT GAZEBO 1.5 X 1.5M KIOSK

SPECIFICATIONS

- Weight:** 8kg
- Hardware:** 1 x frame: aluminium, assembled size: 1.5 x 1.5m, quick assembly, portable
- Bag included:** polyester oxford, size: 156 x 23 x 21cm, webbing handles
- Toolkit included:** 1 x mallet: rubber & wood, 4 x ropes: nylon, 4 x frame pegs: steel, 4 x rope pegs: steel
- Fabric:** print-guard polyester, water resistant
- Branding:** single-sided, latex gen-4 printing
- Half wall visual size:** 1.5 x 1m
- Full wall visual size:** 1.5 x 1.9m



WALL CONFIGURATION	DISPLAY CODE
No walls	VI-AM-169-D
1 x full wall skin	VI-AM-170-D
2 x full wall skins	VI-AM-172-D
3 x full wall skins	VI-AM-174-D
1 x half wall skin	VI-AM-177-D
2 x half wall skins	VI-AM-179-D
3 x half wall skins	VI-AM-184-D
4 x half wall skins	VI-AM-186-D
1 x half wall skin, 1 x full wall skin	VI-AM-188-D
2 x half wall skins, 1 x full wall skin	VI-AM-192-D
3 x half wall skins, 1 x full wall skin	VI-AM-193-D

Refresh the gazebo for multiple campaigns by buying a new skin	
Roof Reskin Code	GZ-AM-45-D
Full Wall Reskin Code	GZ-AM-46-D
Half Wall Reskin Code	GZ-AM-47-D

The compact design and flat roof structure makes this gazebo perfect for indoor and outdoor activations that require quick setups and lend themselves to promotions and brand activations in forecourts and other small areas.



4 attached loops for additional stability, used to secure gazebo with ground pegs and ropes

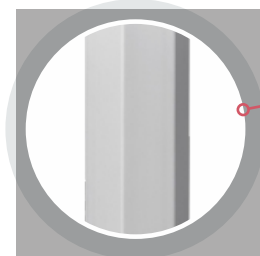

Aluminium hexagonal leg profile for superior strength



Pre-punched feet to easily secure gazebo with ground pegs



Branding is visible on one side only, walls can face inwards (A) or outwards (B)

Images shown are for VI-AM-192-D

GAZEBO FOOTPRINT

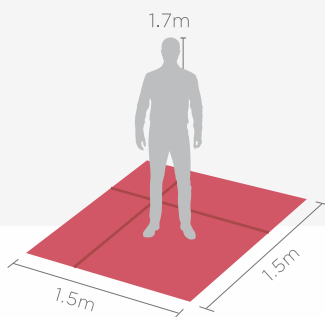

Collapsible gazebo fits easily into carry bag



Carry bag included
(ALSO SOLD INDIVIDUALLY AS DISBAG-2020)



Toolkit included: 1 x mallet, 4 x ropes, 4 x frame pegs, 4 x rope pegs
(ALSO SOLD INDIVIDUALLY AS TOOLKIT-2000)

FADE RESISTANT GAZEBO 2 X 2M

SPECIFICATIONS

Weight: 14kg
Hardware: 1 x frame: aluminium, assembled size: 2 x 2m, quick assembly, portable
Slip over bag included: polyester oxford, size: 158 x 28 x 28cm, webbing handles
Toolkit included: 1 x mallet: rubber & wood, 4 x ropes: nylon, 4 x frame pegs: steel, 4 x rope pegs: steel
Fabric: print-guard polyester, water resistant
Branding: single-sided, latex gen-4 printing
Half wall visual size: 2 x 1m
Full wall visual size: 2 x 1.9m

★★★
OVIATION
 RANGE

WALL CONFIGURATION	DISPLAY CODE
No walls	VI-AM-194-D
1 x full wall skin	VI-AM-195-D
2 x full wall skins	VI-AM-196-D
3 x full wall skins	VI-AM-197-D
1 x half wall skin	VI-AM-198-D
2 x half wall skins	VI-AM-199-D
3 x half wall skins	VI-AM-200-D
4 x half wall skins	VI-AM-201-D
1 x full wall skin, 1 x half wall skin	VI-AM-202-D
1 x full wall skin, 2 x half wall skins	VI-AM-203-D
1 x full wall skin, 3 x half wall skins	VI-AM-204-D

Refresh the gazebo for multiple campaigns by buying a new skin	
Roof Reskin Code	GZ-AM-48-D
Full Wall Reskin Code	GZ-AM-49-D
Half Wall Reskin Code	GZ-AM-50-D



Collapsible gazebo fits easily into carry bag



Toolkit included: 1 x mallet, 4 x ropes, 4 x frame pegs, 4 x rope pegs

(ALSO SOLD INDIVIDUALLY AS TOOLKIT-2000)



Slip over bag included (ALSO SOLD INDIVIDUALLY AS DISBAG-2040)

BAG ON WHEELS FOR 2m GAZEBO SOLD INDIVIDUALLY AS DISPLAY-2001

Pitched roof gazebo, perfect for outdoor events and activations where a smaller footprint is required.



4 attached loops for additional stability, used to secure gazebo with ground pegs and ropes

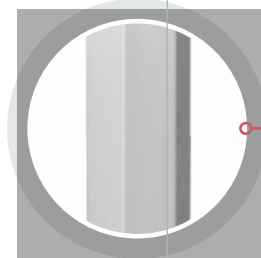

Aluminium hexagonal leg profile for superior strength



Pre-punched feet to easily secure gazebo with ground pegs

GAZEBO FOOTPRINT

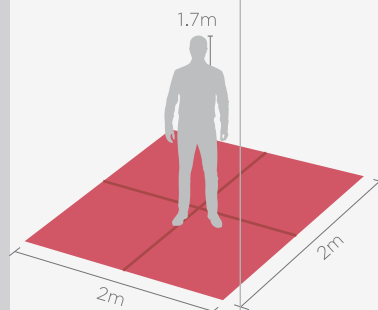

Image shown is for VI-AM-201-D

Branding is visible on one side only, walls can face inwards or outwards

FADE RESISTANT GAZEBO 2 X 2M - PETITE FRAME

SPECIFICATIONS

Weight: 13kg

Hardware: 1 x frame: aluminium, assembled size: 2 x 2m, quick assembly, portable, compact

Slip over bag included: polyester oxford, size: 122 x 28 x 28cm, webbing handles

Toolkit included: 1 x mallet: rubber & wood, 4 x ropes: nylon, 4 x frame pegs: steel, 4 x rope pegs: steel

Fabric: print-guard polyester, water resistant

Branding: single-sided, latex gen-4 printing

Half wall visual size: 2 x 1m

Full wall visual size: 2 x 1.85m



WALL CONFIGURATION	DISPLAY CODE
No walls	VI-AM-166-D
1 x full wall skin	VI-AM-164-D
2 x full wall skins	VI-AM-162-D
3 x full wall skins	VI-AM-160-D
1 x half wall skin	VI-AM-159-D
2 x half wall skins	VI-AM-158-D
3 x half wall skins	VI-AM-156-D
4 x half wall skins	VI-AM-154-D
1 x half wall skin, 1 x full wall skin	VI-AM-153-D
2 x half wall skins, 1 x full wall skin	VI-AM-151-D
3 x half wall skins, 1 x full wall skin	VI-AM-149-D

Refresh the gazebo for multiple campaigns by buying a new skin	
Roof Reskin Code	GZ-AM-48-D
Full Wall Reskin Code	GZ-AM-58-D
Half Wall Reskin Code	GZ-AM-50-D

This gazebo is perfect for brand activations, product launches, sporting events and mobile retail shops to mention a few. The Petite Gazebo features extra collapsible legs that slide in making it compact and portable allowing for easy transportation.



4 attached loops for additional stability, used to secure gazebo with ground pegs and ropes

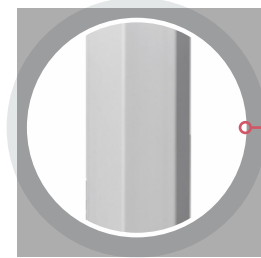

Aluminium hexagonal leg profile for superior strength



Pre-punched feet to easily secure gazebo with ground pegs



GAZEBO FOOTPRINT

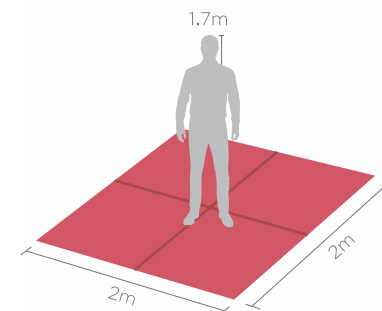

Collapsible gazebo fits easily into carry bag



Slip over bag included
(ALSO SOLD INDIVIDUALLY AS DISBAG-2140)

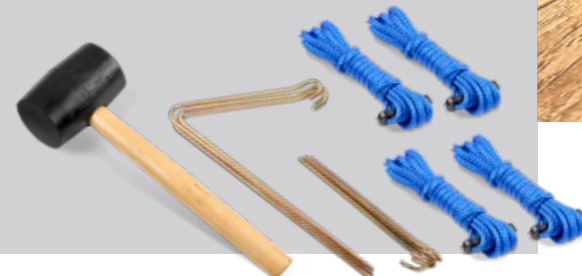

Toolkit included: 1 x mallet, 4 x ropes, 4 x frame pegs, 4 x rope pegs
(ALSO SOLD INDIVIDUALLY AS TOOLKIT-2000)

Image shown is for VI-AM-151-D

Branding is visible on one side only, walls can face inwards or outwards

FADE RESISTANT GAZEBO 3 X 3M

SPECIFICATIONS

- Weight:** 19kg
- Hardware:** 1 x frame: aluminium, assembled size: 3 x 3m, quick assembly, portable
- Slip over bag included:** polyester oxford, size: 158 x 28 x 28cm, webbing handles
- Toolkit Included:** 1 x mallet: rubber & wood, 4 x ropes: nylon, 4 x frame pegs: steel, 4 x rope pegs: steel
- Fabric:** print-guard polyester, water resistant
- Branding:** single-sided, latex gen-4 printing
- Half wall visual size:** 3 x 1m
- Full wall visual size:** 3 x 1.9m



WALL CONFIGURATION	DISPLAY CODE
No walls	VI-AM-205-D
1 x full wall skin	VI-AM-206-D
2 x full wall skins	VI-AM-207-D
3 x full wall skins	VI-AM-208-D
1 x half wall skin	VI-AM-209-D
2 x half wall skins	VI-AM-191-D
3 x half wall skins	VI-AM-190-D
4 x half wall skins	VI-AM-189-D
1 x half wall skin, 1 x full wall skin	VI-AM-187-D
2 x half wall skins, 1 x full wall skin	VI-AM-185-D
3 x half wall skins, 1 x full wall skin	VI-AM-183-D

Refresh the gazebo for multiple campaigns by buying a new skin	
Roof Reskin Code	GZ-AM-51-D
Full Wall Reskin Code	GZ-AM-52-D
Half Wall Reskin Code	GZ-AM-53-D

GAZEBO FOOTPRINT

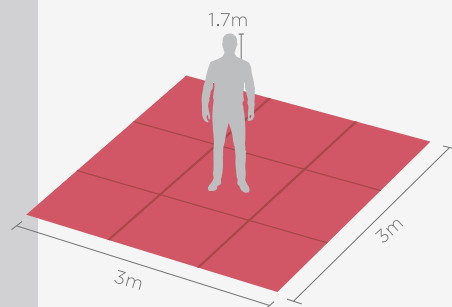

Collapsible gazebo fits easily into carry bag



Slip over bag included
(ALSO SOLD INDIVIDUALLY AS DISBAG-2040)



(ALSO SOLD INDIVIDUALLY AS TOOLKIT-2000)



BAG ON WHEELS FOR 3m GAZEBO
SOLD INDIVIDUALLY AS DISPLAY-2001

With a slightly bigger footprint, this gazebo size is ideal for brand activations, product launches, sporting events and mobile retail to mention a few.



4 attached loops for additional stability, used to secure gazebo with ground pegs and ropes

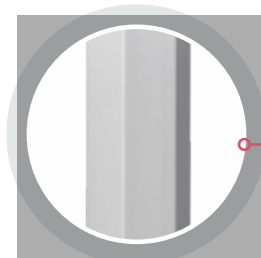

Aluminium hexagonal leg profile for superior strength



Pre-punched feet to easily secure gazebo with ground pegs



Image shown is for VI-AM-208-D

Branding is visible on one side only, walls can face inwards or outwards

**FADE RESISTANT GAZEBO
4.5 X 3M**

SPECIFICATIONS

- Weight:** 25kg
- Hardware:** 1 x frame: aluminium, assembled size: 4.5 x 3m, quick assembly, portable
- Slip over bag included:** polyester oxford, size: 158 x 29 x 31cm, webbing handles
- Toolkit included:** 1 x mallet: rubber & wood, 4 x ropes: nylon, 4 x frame pegs: steel, 4 x rope pegs: steel
- Fabric:** print-guard polyester, water resistant
- Branding:** single-sided, latex gen-4 printing
- Short half wall visual size:** 3 x 1m
- Long full wall visual size:** 4.5 x 1.9m
- Short full wall visual size:** 3 x 1.9m



WALL CONFIGURATION	DISPLAY CODE
No walls	VI-AM-182-D
1 x long full wall skin	VI-AM-181-D
2 x long full wall skins	VI-AM-180-D
1 x long full wall skin, 1 x short full wall skin	VI-AM-178-D
1 x long full wall skin, 2 x short half wall skins	VI-AM-176-D
1 x short full wall skin	VI-AM-175-D
2 x short full wall skins	VI-AM-173-D
2 x short half wall skins	VI-AM-171-D
1 x short half wall skin, 1 x long full wall skin	VI-AM-168-D

Refresh the gazebo for multiple campaigns by buying a new skin	
Roof Reskin Code	GZ-AM-54-D
Long Full Wall Reskin Code	GZ-AM-55-D
Short Full Wall Reskin Code	GZ-AM-56-D
Short Half Wall Reskin Code	GZ-AM-57-D

GAZEBO FOOTPRINT

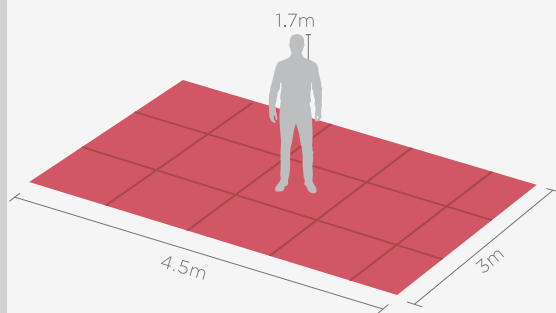

This gazebo has a slightly bigger footprint, accommodating for extra retail or display space. Perfectly fits 2 trestle tables under roof and big enough to fit 1 vehicle. That extra space might come in handy depending on the activation, product launch or event at hand.



4 attached loops for additional stability, used to secure gazebo with ground pegs and ropes



Collapsible gazebo fits easily into carry bag



Slip over bag included

(ALSO SOLD INDIVIDUALLY AS DISBAG-2080)

Toolkit included: 1 x mallet, 4 x ropes, 4 x frame pegs, 4 x rope pegs

(ALSO SOLD INDIVIDUALLY AS TOOLKIT-2000)

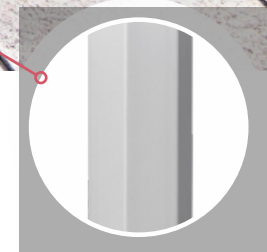

Aluminium hexagonal leg profile for superior strength



Pre-punched feet to easily secure gazebo with ground pegs

Image shown is for VI-AM-178-D

Branding is visible on one side only, walls can face inwards or outwards

OUTDOOR DISPLAY

FADE RESISTANT GAZEBO 6 X 3M

SPECIFICATIONS

- Weight:** 32kg
- Hardware:** 1 x frame: aluminium, assembled size: 6 x 3m, quick assembly, portable
- Bag included:** polyester oxford, size: 158 x 28 x 43cm, webbing handles
- Toolkit Included:** 1 x mallet: rubber & wood, 6 x ropes: nylon, 6 x frame pegs: steel, 4 x rope pegs: steel
- Fabric:** print-guard polyester, water resistant
- Branding:** single-sided, latex gen-4 printing
- Short half wall visual size:** 3 x 1m
- Long full wall visual size:** 6 x 1.9m
- Short full wall visual size:** 3 x 1.9m



WALL CONFIGURATION	DISPLAY CODE
No walls	VI-AM-147-D
1 x long full wall skin	VI-AM-150-D
2 x long full wall skins	VI-AM-152-D
1 x long full wall skin, 1 x short full wall skin	VI-AM-155-D
1 x long full wall skin, 2 x short half wall skins	VI-AM-157-D
1 x short full wall skin	VI-AM-161-D
2 x short full wall skins	VI-AM-163-D
2 x short half wall skins	VI-AM-165-D
1 x short half wall skin, 1 x long full wall skin	VI-AM-167-D

Refresh the gazebo for multiple campaigns by buying a new skin	
Roof Reskin Code	GZ-AM-41-D
Long Full Wall Reskin Code	GZ-AM-42-D
Short Full Wall Reskin Code	GZ-AM-43-D
Short Half Wall Reskin Code	GZ-AM-44-D

From outdoor events to corporate functions, this lightweight gazebo is the perfect display solution. It is fully collapsible and easy to setup, not mention fully customisable in terms of the number of walls and branding options. Branded Gazebos are a popular and affordable means of advertising.

OUTDOOR DISPLAY



4 attached loops for additional stability, used to secure gazebo with ground pegs and ropes



GAZEBO FOOTPRINT

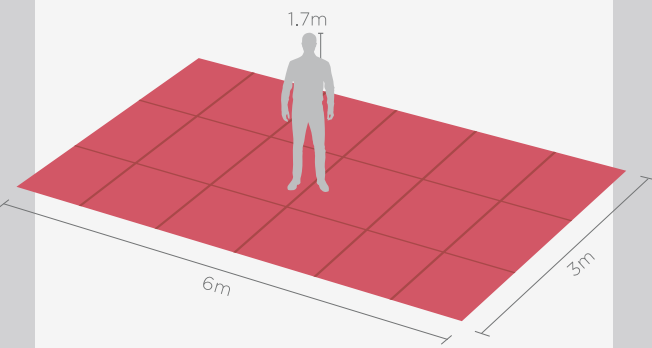

Collapsible gazebo fits easily into carry bag



Slip over bag included
(ALSO SOLD INDIVIDUALLY AS DISBAG-2010)

Toolkit included:
1 x mallet, 6 x ropes,
6 x frame pegs, 6 x rope pegs
(ALSO SOLD INDIVIDUALLY AS TOOLKIT-2010)

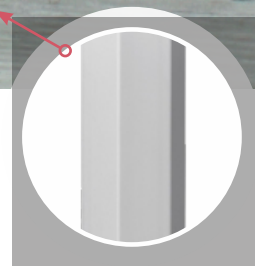

Aluminium hexagonal leg profile for superior strength



Pre-punched feet to easily secure gazebo with ground pegs

Image shown is for VI-AM-150-D

Branding is visible on one side only, walls can face inwards or outwards